

# AUDIO & VIDEO DOOR ENTRY SYSTEMS



## CATALOGUE

KITS AND SYSTEM SOLUTIONS FOR SINGLE  
HOUSES, BUILDINGS AND COMPOUNDS



## BTICINO

### Specialists in Video Door Entry Systems

**BTicino**, introduces a complete range of products and systems capable of meeting all application and building requirements. From single homes to larger buildings and apartment complexes, BTicino can offer the right solution to satisfy both the private user and the professional.

# Index

4-5	Offer overview	Different solutions for different applications	4
6-33	EASYKIT	EASY KITS (two wires)	6
34-43	BASIC KITS	BASIC KITS (four wires)	34
44-57	PROFESSIONAL KITS	Features overview	44
		Villa CONNECTED VIDEO KITS (two wires)	48
		Villa VIDEO KITS (two wires)	52
		Villa AUDIO KITS (two wires)	54
		Villa ANALOGUE AUDIO KITS	56
58-119	2 Wires System	System overview	58
		Entrance panels range	62
		Internal units range	84
		System accessories range	114
120-140	IP System	System overview	120

# DIFFERENT SOLUTIONS FOR DIFFERENT APPLICATIONS

## EASYKIT - BASIC KITS

for standard level villas



Closed solution that provides **BASIC FUNCTIONS**, normally for simple systems:



- ONE OR TWO FAMILY HOMES
- READY MADE SOLUTIONS
- EXPANDABLE SOLUTIONS
- PLUG-IN OR DIN POWER SUPPLY

## PROFESSIONAL KITS

for high level villas



Initial basic solution that **CAN DEVELOP** into a **MORE COMPLEX** and **CUSTOMISED** systems:



- ONE OR TWO-FAMILY HOMES
- READY MADE SOLUTIONS
- FULLY EXPANDABLES
- ENHANCED FUNCTIONS



## From villas to multi-family units



Villas

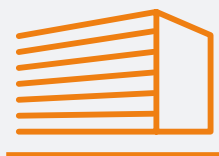

Small building



Building complex

Different types of constructions mean different types of offer

### 2 WIRES SYSTEM

for small buildings



The best technology when **TIME SAVING** and **EASE** of **INSTALLATION** are required:

### IP SYSTEM

for building complex



The system conceived for **BIG RESIDENTIAL BUILDINGS** where IP cabling is required.



- SMALL BUILDINGS/HOMES
- EASY AND QUICK TO INSTALL
- MAXIMUM VERSATILITY
- PERFECT FOR REFURBISHMENTS

- LARGER BUILDINGS AND COMPLEXES
- HIGH PERFORMANCES
- LONG DISTANCES AND HIGH NUMBER OF APARTMENTS
- INTEGRATED SECURITY FUNCTIONS

# EASYKIT



- **Easy** installation
- **Expandability** with additional internal units, entrance panel and CCTV camera
- **Connected Wifi** solution available
- **Door lock** release key and **intercom functions**
- **Plug-in** and **DIN** power supply

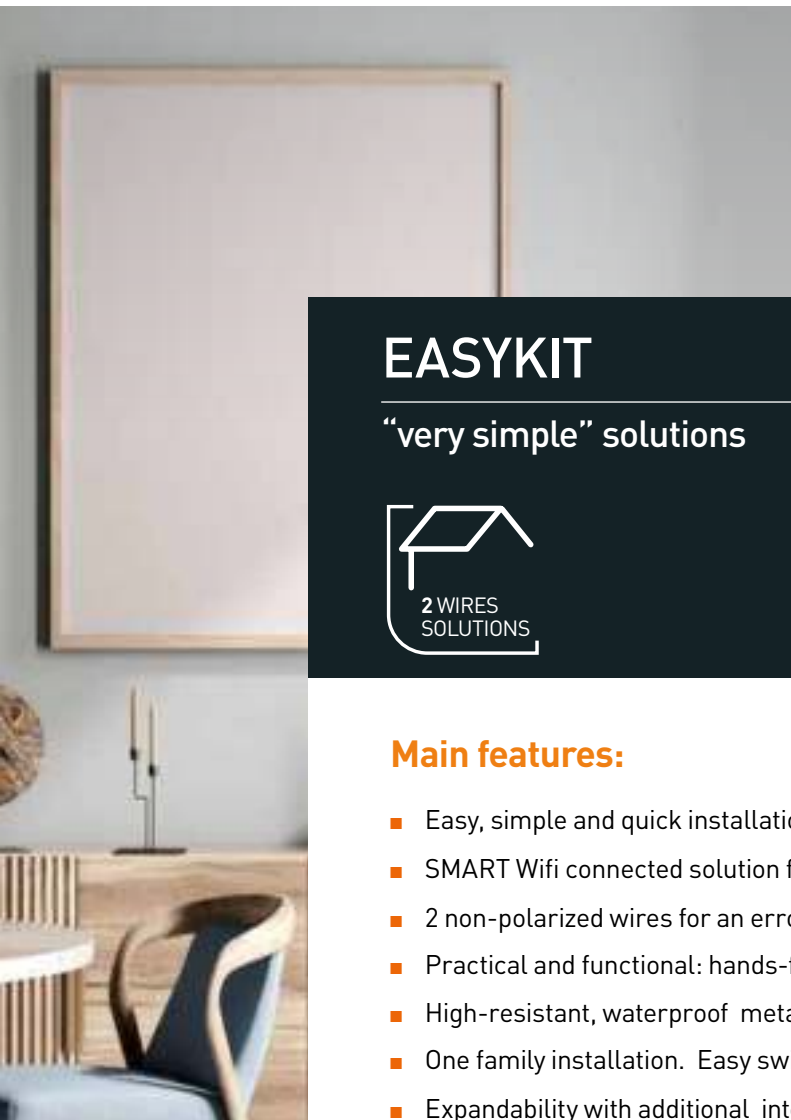

# EASYKIT

“very simple” solutions



## Hands-free video kits comprising:

- a wall-mounting metal entrance panel (rainshield included) equipped with a colour camera and a LED lamp for the illumination of the field of view.
- a video colour display internal unit (plug-in power supply included).

## Main features:

- Easy, simple and quick installation
- SMART Wifi connected solution for your security
- 2 non-polarized wires for an error-proof connection
- Practical and functional: hands-free solutions enabling dialogue while moving freely
- High-resistant, waterproof metal entrance panels
- One family installation. Easy switch to two families by adding the additional internal unit
- Expandability with additional internal units, entrance panel and CCTV camera.

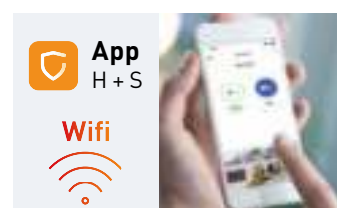
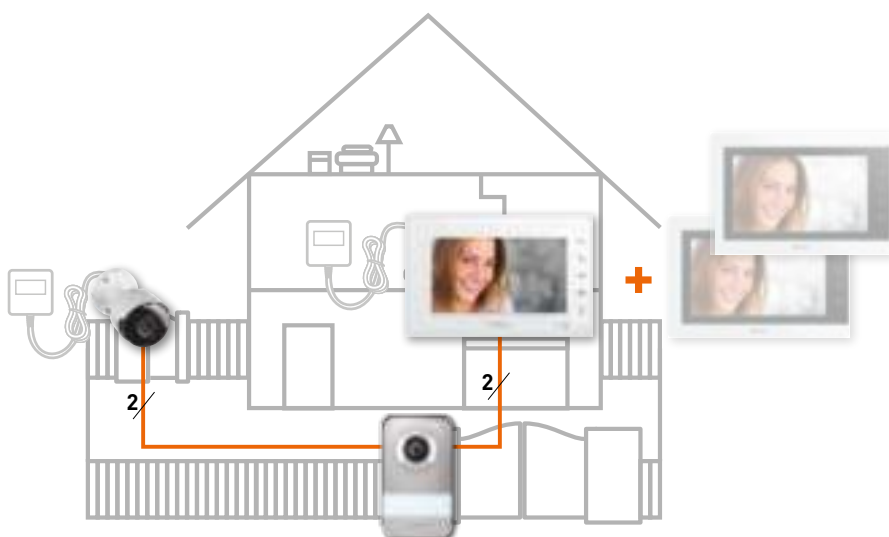

CONNECTED VERSION	CAMERA INTEGRATION	PLUG-IN OR DIN POWER SUPPLY	EXPANDABLE	IDEAL FOR REFURBISHMENTS
-------------------	--------------------	-----------------------------	------------	--------------------------



# Easykit Wifi

SMART SOLUTION  
FOR YOUR SECURITY



Home + Security





Answer the calls,  
activate the electrical door locks,  
activate the cameras and display  
the timeline of the events

-  
Manage up to 20 homes  
with your single account



Home + Security



**Incoming call**

Receive notification  
when someone  
is calling

**See who's calling**

Answer the call and  
open the gate for  
the courier

**Check the events**

Check who called you  
and if they left you  
a message

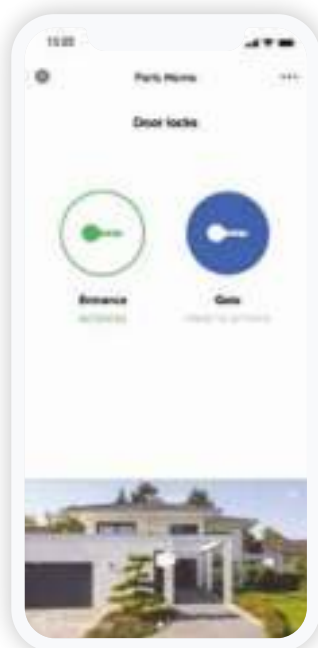
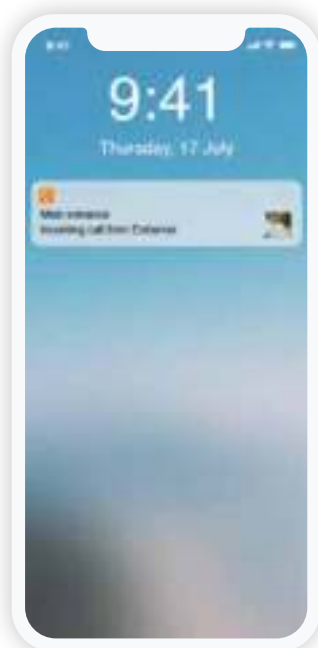

**Quick actions**

- Activate the electrical door locks
- Activate the timed staircase lights
- Call home / Intercom
- Activate the cameras



Security enhancement with integration of Netatmo devices

# Video door entry system and security. Together.

<p><b>Video door entry system</b> ...</p>  <p><b>Main entrance</b> Incoming entrance call.</p>	<p><b>Security</b> ...</p>  <p><b>Secondary entrance and interiors</b> Smart Outdoor Camera with Siren and movement detection. Smart Indoor Camera with face recognition.</p>
--	--

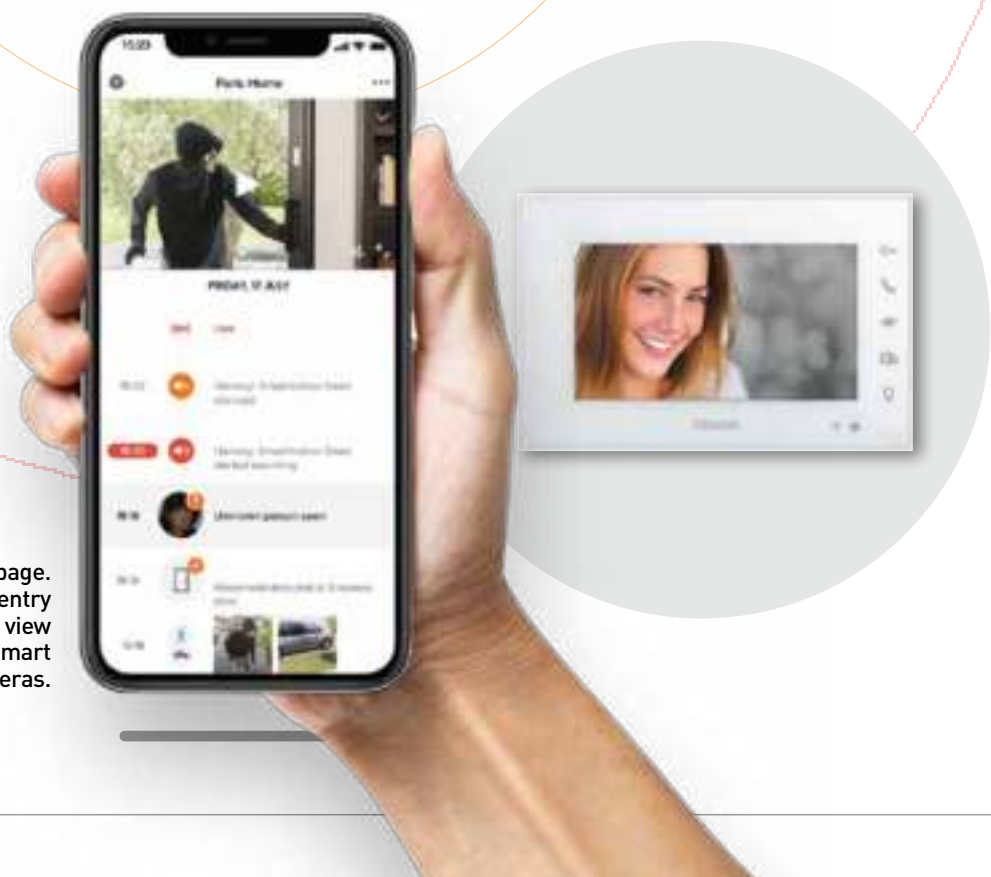

A single App with an intuitive home page. It allows you to answer video door entry calls, activate the door lock and view images from Netatmo smart outdoor and indoor cameras.



**Professional opportunity:** offer your services as an installer of simple smart security systems.  
**Business opportunities:** access to a catalogue of smart and easy-to-install security devices.

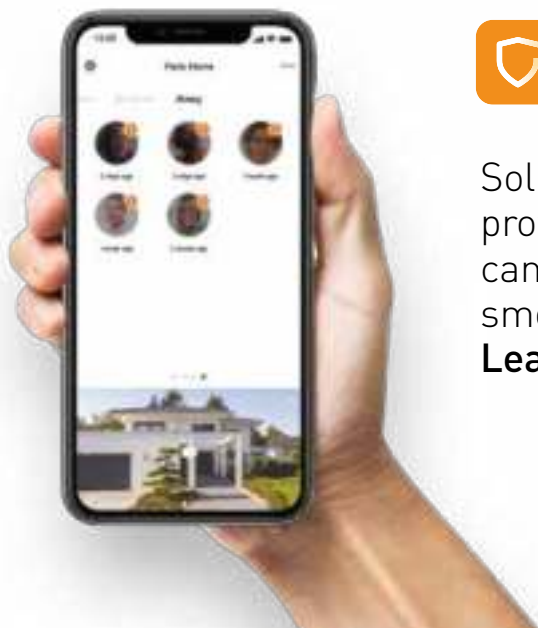

**Home + Security**  
**The best App for a safe home.**

Solutions for a smart and complete protection of your home: security cameras, alarms, opening sensors, smoke detector...

**Leave your home without worries.**

WITH  
**Netatmo**

**Examples of Netatmo solutions natively integrated in the Home + Security App**



Smart Outdoor Camera



Smart Outdoor Camera with Siren



Smart Indoor Camera



Smart Door and Window Sensors



Smart Video Doorbell



Smart Indoor Siren



Smart Smoke Alarm



Smart Carbon Monoxide Alarm

# BTICINO BRAND KITS



**ONE**  
FAMILY HOUSE



EXISTING INTERNAL UNIT

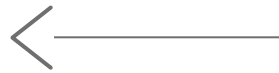

**TWO**  
FAMILY HOUSE



EXISTING INTERNAL UNIT

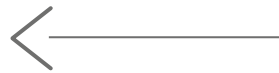
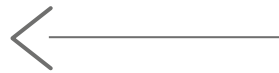





You can turn your existing system into a connected one by simply replacing the video internal unit **without structural changes.**



CONNECTED INTERNAL UNIT  
**BT-335253**  
**BT-335254**



# EASYKIT SOLUTIONS

CHOOSE YOUR KIT...

## 7" inch easykit Wifi video kits

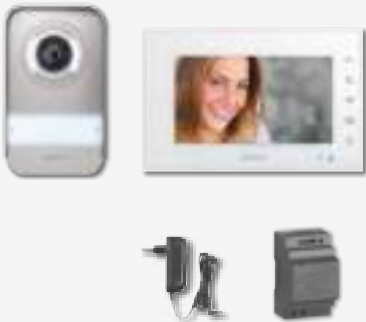

- Wifi connectivity
- Management from smartphone via Home + Security app
- 7 Inch colour monitor with soft touch buttons
- White finish
- Double opening (door and gate)
- Light activation
- Integration with Netatmo Smart Cameras and Security devices
- Additional CCTV camera
- Entrance panel can call 2 apartments
- Plug-In or DIN power supply

## 7" inch easykit plus video kits



- Simple and modern
- 7 Inch colour monitor with soft touch buttons
- Mirror effect design
- Black finish
- Double opening (door and gate)
- Light activation
- Additional CCTV camera
- Entrance panel can call 2 apartments
- Plug-In or DIN power supply

## 7" mirror effect / white finish video kits







- Practical and essential
- 7 Inch colour monitor with soft touch buttons
- White finish
- Double opening (door and gate)
- Additional CCTV camera
- Entrance panel can call 2 apartments
- Plug-In or DIN power supply



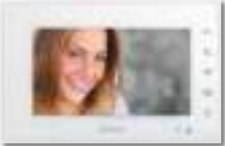

## AND EXPAND IT

All Easykits can be expanded up to a maximum of 3 internal units and one additional entrance panel or CCTV camera for each apartment. Only one easy kit connected per home can be installed.

7 Inch Wifi additional internal units	7 Inch Plus additional internal units	7 Inch Essential additional internal units	Additional entrance panel additional camera
			
<p><b>Plug-In or DIN Power supply</b></p>	<p><b>Plug-In or DIN Power supply</b></p>	<p><b>Plug-In or DIN Power supply</b></p>	<p><b>ENTRANCE PANEL durable aluminium finishing</b></p> <ul style="list-style-type: none"> <li>■ Practical 2-wires installation</li> <li>■ Weatherproof (IP54)</li> <li>■ Metal protective rainshield</li> <li>■ IK07 degree of protection</li> <li>■ Wide-angle camera (105°)</li> <li>■ LED light and night vision</li> <li>■ Adaptable for one or two-family houses</li> <li>■ Can be connected to a security camera</li> </ul>



# EASYKIT

## WITH PLUG-IN POWER SUPPLY

2 WIRES



### 7" WHITE FINISH **EASYKIT Wifi with Netatmo** WITH PLUG-IN POWER SUPPLY

One family two wires colour **EASYKIT Wifi with Netatmo** connected video kit with plug-in power supply and wall mounted entrance panel that can be easily adapted for two family houses. An external CCTV colour camera can be directly connected to the entrance panel. Wifi connected handsfree 7" screen internal unit white finish with European Plug-In power supply included. The system can be expanded up to 3 traditional handsfree internal units. Thanks to the Wifi connection, you can associate the video internal unit to the HOME + SECURITY App (available for Android and iOS).

You can manage by the App the main video internal unit functions (receiving calls, opening the door lock, view the cameras). Through the same App, it is also possible to manage the products of the Netatmo security range (outdoor and indoor cameras, door and window sensors, indoor siren and smoke detector).

This allows you to quickly and easily create a Smart security system.



### 7" MIRROR BLACK FINISH **EASYKIT PLUS** WITH PLUG-IN POWER SUPPLY

One family two wires colour **EASYKIT Plus** video kit with plug-in power supply and wall mounted entrance panel that can be easily adapted for two family houses.

An external CCTV colour camera can be directly connected to the entrance panel. Handsfree 7" screen internal unit black finish mirror effect, with touch control commands for main functions and European Plug-In power supply included.

The system can be expanded up to 3 traditional handsfree internal units.



### 7" WHITE FINISH **EASYKIT ESSENTIAL** WITH PLUG-IN POWER SUPPLY

One family two wires colour **EASYKIT Essential** video kit with plug-in power supply and wall mounted entrance panel that can be easily adapted for two family houses.





An external CCTV colour camera can be directly connected to the entrance panel. Handsfree 7" screen internal unit white finish with touch control commands for main functions and European Plug-In power supply included.

The system can be expanded up to 3 traditional handsfree internal units.



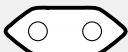



PLUG-IN PWS (included)	EASYKIT Wifi with Netatmo	EASYKIT PLUS	EASYKIT ESSENTIAL
<b>European standard</b> 	<b>BT-310913</b> 7 inch white finish screen <b>Wifi with Netatmo KIT</b>	<b>BT-318913</b> 7 inch black finish screen <b>Plus KIT</b>	<b>BT-317913</b> 7 inch white finish screen <b>Essential kit</b>
	<b>BT-335253</b> 7 inch white finish <b>additional Wifi with Netatmo Internal unit</b>	<b>BT-334253</b> 7 inch black finish <b>additional Plus Internal unit</b>	<b>BT-333253</b> 7 inch white finish <b>additional Essential Internal unit</b>
<b>Video colour entrance panel</b> 	<b>BT-331860</b> (Additional colour entrance panel with rainshield)		
<b>Additional External camera</b> 	<b>BT-391441</b> (European standard PLUG Colour external camera)		
<b>Spare part Power supply</b> 	<b>BT-SP101</b> (Spare part plug-in power supply)		



**NOTE:** internal units are all compatible. As additional internal unit you can use any of the range.

# BTICINO BRAND KITS

## EASYKIT with PLUG-IN POWER SUPPLY



BT-310913



BT-318913



BT-317913



BT-335253



BT-334253



BT-333253

Item	7" White finish <b>EASYKIT Wifi</b> with plug-in power supply
BT-310913	<p>One family two wires colour <b>EASYKIT Wifi connected video kit with plug-in power supply and wall mounted entrance panel</b>. Metal finish entrance panel with rainshield, colour wide angle camera and LED for the night illumination of the field of view. Entrance panel can be easily adapted for two family houses. An external CCTV colour camera can be directly connected to the entrance panel.</p> <p>Wifi connected handsfree 7" screen internal unit white finish with European PLUG-IN std power supply included. The system can be expanded up to 3 traditional handsfree internal units.</p> <p>Thanks to the Wifi connection, you can associate the video internal unit to the Home + Security App (available for Android and iOS). You can manage by the App the main video internal unit functions (receiving calls, opening the door lock, view the cameras). Through the same App, it is also possible to manage the products of the Netatmo security range (outdoor and indoor cameras, door and window sensors, indoor siren and smoke detector). This allows you to quickly and easily create a Smart security system.</p>
BT-335253	<p><b>Additional video internal units</b></p> <p><b>Additional EASYKIT Wifi connected handsfree 7" screen internal unit white finish</b> with EU standard plug-in power supply included. Touch control commands for main functions. Wall mounting installation. Thanks to the Wifi connection, you can associate the video internal unit to the Home + Security App (available for Android and iOS).</p>
BT-334253	<p><b>Additional EASYKIT Plus handsfree 7" screen internal unit black finish mirror effect</b> with EU standard plug-in power supply included. Touch control commands for main functions. Wall mounting installation.</p>
BT-333253	<p><b>Additional handsfree 7" EASYKIT Essential screen internal unit white finish</b> with EU standard plug-in power supply included. Touch control commands for main functions. Wall mounting installation.</p>

Item	7" Mirror black finish <b>EASYKIT Plus</b> with plug-in power supply
BT-318913	<p>One family two wires colour <b>EASYKIT Plus video kit with plug-in power supply and wall mounted entrance panel</b>. Metal finish entrance panel with rainshield, colour wide angle camera and LED for the night illumination of the field of view. Entrance panel can be easily adapted for two family houses. An external CCTV colour camera can be directly connected to the entrance panel.</p> <p>Handsfree 7" screen internal unit black finish mirror effect, with touch control commands for main functions and European PLUG-IN std power supply included. The system can be expanded up to 6 internal units (3 per entrance panel) and up to 2 entrance panels.</p>
BT-317913	<p><b>7" Mirror black finish EASYKIT Essential with plug-in power supply</b></p> <p>One family two wires colour <b>EASYKIT Essential video kit with plug-in power supply and wall mounted entrance panel</b>. Metal finish entrance panel with rainshield, colour wide angle camera and LED for the night illumination of the field of view. Entrance panel can be easily adapted for two family houses. An external CCTV colour camera can be directly connected to the entrance panel.</p> <p>Handsfree 7" screen internal unit white finish with touch control commands for main functions and European PLUG-IN std power supply included. The system can be expanded up to 6 internal units (3 per entrance panel) and up to 2 entrance panels.</p>



BT-331860



BT-391441



BT-SP101

**Wiring diagram example**

- Item Additional video entrance panel with rainshield**
- BT-331860 Additional video colour entrance panel with rainshield. Wide angle colour camera (105°). IP54 Protection degree.
- Additional external camera**
- BT-391441 Additional external colour camera with coaxial video output, metal case and 3.6 mm fixed lens. Night vision. Power supply 100-240 Vac / 50-60 Hz (12 VDC Plug-in power supply with EU standard socket supplied). Degree of protection IP66 – degree of robustness IK07. Can be connected directly to the entrance panel.
- Plug-In power supply**
- BT-SP101 Plug-In power supply with EU Standard plug. Nominal input voltage : 110 - 240 Vac @ 50/60 Hz. Output : 30 Vdc - 1 A. Integrated fuse on PRI side (F1 T2A 250 V).

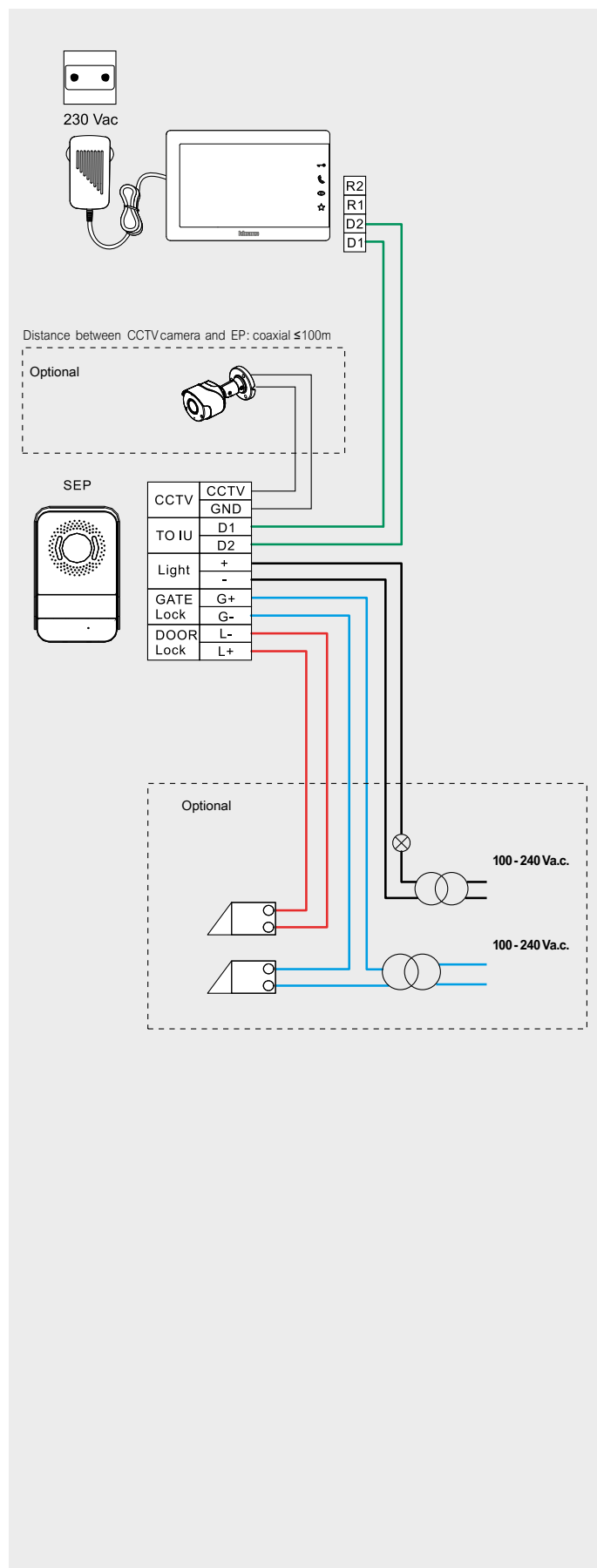

# EASYKIT

## WITH DIN POWER SUPPLY

2 WIRES



### 7" WHITE FINISH EASYKIT Wifi with Netatmo WITH DIN POWER SUPPLY

One family two wires colour **EASYKIT Wifi with Netatmo** connected video kit with 2-DIN modules power supply and wall mounted entrance panel that can be easily adapted for two family houses.

An external CCTV colour camera can be directly connected to the entrance panel. Wifi connected handsfree 7" screen internal unit white finish.

The system can be expanded up to 3 traditional handsfree internal units. Thanks to the Wifi connection, you can associate the video internal unit to the HOME + SECURITY App (available for Android and iOS). You can manage by the App the main video internal unit functions (receiving calls, opening the door lock, view the cameras). Through the same App, it is also possible to manage the products of the Netatmo security range (outdoor and indoor cameras, door and window sensors, indoor siren and smoke detector).

This allows you to quickly and easily create a Smart security system.



### 7" MIRROR BLACK FINISH EASYKIT PLUS WITH DIN POWER SUPPLY

One family two wires colour **EASYKIT Plus** video kit with 2-DIN modules power supply and wall mounted entrance panel that can be easily adapted for two family houses.

An external CCTV colour camera can be directly connected to the entrance panel. Handsfree 7" screen internal unit black finish mirror effect, with touch control commands for main functions.

The system can be expanded up to 3 traditional handsfree internal units.



### 7" WHITE FINISH EASYKIT ESSENTIAL WITH DIN POWER SUPPLY

One family two wires colour **EASYKIT Essential** video kit with 2-DIN modules power supply and wall mounted entrance panel that can be easily adapted for two family houses.

An external CCTV colour camera can be directly connected to the entrance panel. Handsfree 7" screen internal unit white finish with touch control commands for main functions.

The system can be expanded up to 3 traditional handsfree internal units.







DIN power supply (included)	EASYKIT Wifi with Netatmo	EASYKIT PLUS	EASYKIT ESSENTIAL
	<b>BT-310914</b> 7" inch white finish screen <b>Wifi with Netatmo KIT</b>	<b>BT-318914</b> 7" inch black finish screen <b>Plus KIT</b>	<b>BT-317914</b> 7" inch white finish screen <b>Essential kit</b>
	<b>BT-335254</b> 7" inch white finish <b>additional Wifi with Netatmo Internal unit</b>	<b>BT-334254</b> 7" inch black finish <b>additional Plus Internal unit</b>	<b>BT-333254</b> 7" inch white finish <b>additional Essential Internal unit</b>
<b>Video colour entrance panel</b> 	<b>BT-331860</b> (Additional colour entrance panel with rainshield)		
<b>Additional External camera</b> 	<b>BT-391441</b> (European standard PLUG Colour external camera)		
<b>Spare part Power supply</b> 	<b>BT-SP102</b> (2-DIN Spare part power supply)		



**NOTE:** internal units are all compatible. As additional internal unit you can use any of the range.

# BTICINO BRAND KITS

## EASYKIT with DIN POWER SUPPLY



BT-310914



BT-318914



BT-317914



BT-335254



BT-334254



BT-333254

Item	7" White finish <b>EASYKIT Wifi with DIN power supply</b>
BT-310914	<p>One family two wires colour <b>EASYKIT Wifi connected video kit with DIN power supply and wall mounted entrance panel</b>. Metal finish entrance panel with rainshield, colour wide angle camera and LED for the night illumination of the field of view. Entrance panel can be easily adapted for two family houses. An external CCTV colour camera can be directly connected to the entrance panel.</p> <p>Wifi connected handsfree 7" screen internal unit white finish with 2 DIN modules power supply included. The system can be expanded up to 3 traditional handsfree internal units.</p> <p>Thanks to the Wifi connection, you can associate the video internal unit to the Home + Security App (available for Android and iOS). You can manage by the App the main video internal unit functions (receiving calls, opening the door lock, view the cameras). Through the same App, it is also possible to manage the products of the Netatmo security range (outdoor and indoor cameras, door and window sensors, indoor siren and smoke detector). This allows you to quickly and easily create a Smart security system.</p>

<b>Additional video internal units</b>	
BT-335254	<p><b>Additional EASYKIT Wifi connected handsfree 7" screen internal unit in white finish.</b> Touch control commands for main functions. Wall mounting installation. Thanks to the Wifi connection, you can associate the video internal unit to the Home + Security App (available for Android and iOS).</p>

BT-334254	<p><b>Additional EASYKIT Plus handsfree 7" screen internal unit black finish mirror effect.</b> Touch control commands for main functions. Wall mounting installation.</p>
-----------	--

BT-333254	<p><b>Additional handsfree 7" EASYKIT Essential screen internal unit white finish.</b> Touch control commands for main functions. Wall mounting installation.</p>
-----------	---

Item	7" Mirror black finish <b>EASYKIT Plus with DIN power supply</b>
BT-318914	<p>One family two wires colour <b>EASYKIT Plus video kit with DIN power supply and wall mounted entrance panel</b>. Metal finish entrance panel with rainshield, colour wide angle camera and LED for the night illumination of the field of view. Entrance panel can be easily adapted for two family houses. An external CCTV colour camera can be directly connected to the entrance panel.</p> <p>Handsfree 7" screen internal unit black finish mirror effect, with touch control commands for main functions and DIN power supply included. The system can be expanded up to 6 internal units (3 per entrance panel) and up to 2 entrance panels.</p>
BT-317914	<p><b>7" Mirror black finish EASYKIT Essential with DIN power supply</b></p> <p>One family two wires colour <b>EASYKIT Essential video kit with DIN power supply and wall mounted entrance panel</b>. Metal finish entrance panel with rainshield, colour wide angle camera and LED for the night illumination of the field of view. Entrance panel can be easily adapted for two family houses. An external CCTV colour camera can be directly connected to the entrance panel.</p> <p>Handsfree 7" screen internal unit white finish with touch control commands for main functions and DIN power supply included. The system can be expanded up to 6 internal units (3 per entrance panel) and up to 2 entrance panels.</p>



BT-331860



BT-391441



BT-SP102

**Wiring diagram example**

- Item Additional video entrance panel with rainshield**

BT-331860 Additional video colour entrance panel with rainshield. Wide angle colour camera (105°). IP54 Protection degree.
- Additional external camera**

BT-391441 Additional external colour camera with coaxial video output, metal case and 3.6 mm fixed lens. Night vision. Power supply 100-240 Vac / 50-60 Hz (12 VDC Plug-in power supply with EU standard socket supplied). Degree of protection IP66 – degree of robustness IK07. Can be connected directly to the entrance panel.
- Plug-In power supply**

BT-SP102 2 DIN module power supply. Nominal input voltage : 85 - 264 Vac @ 50/60 Hz. Output: 24 Vdc - 2.5 A. It must only be installed indoors and only in switchboards set up for DIN devices. Use an omnipolar switch with separation between the contacts of at least 3 mm positioned near the power supply.

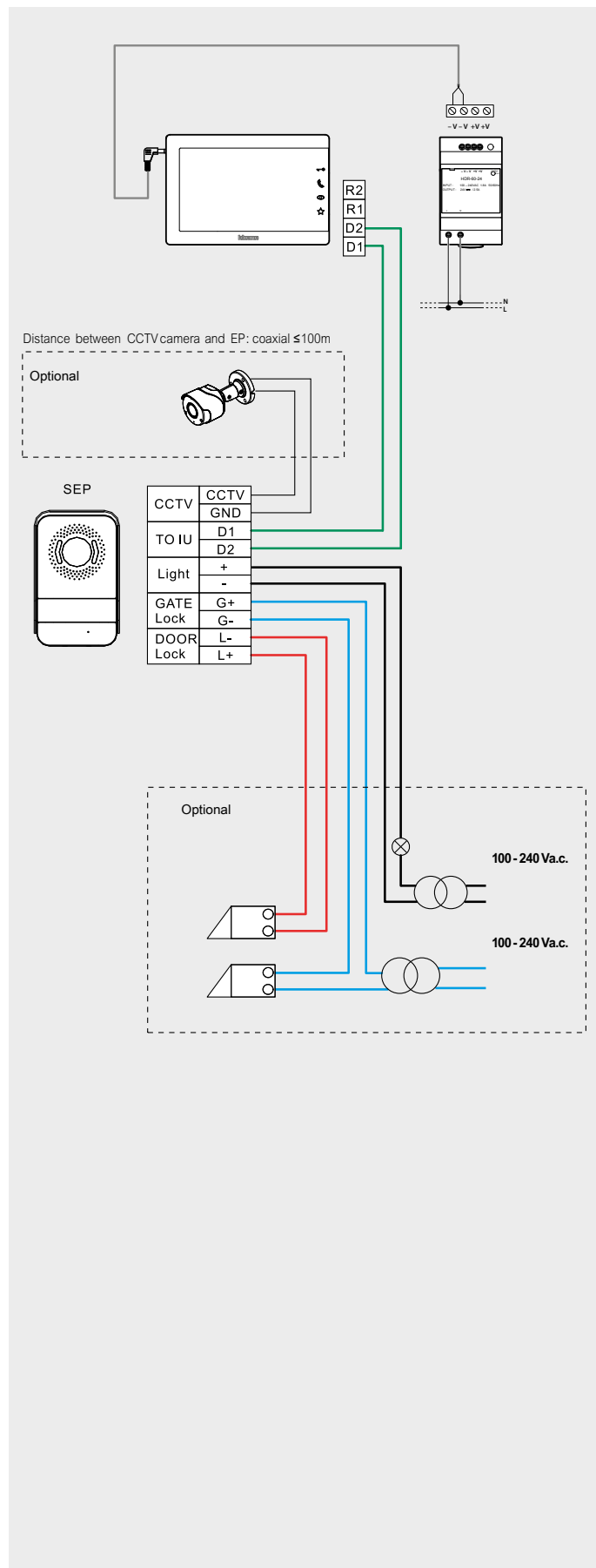

# EASYKIT

## WITH PLUG-IN POWER SUPPLY

— 2 WIRES



### 7" WHITE FINISH **EASYKIT Wifi with Netatmo**

#### WITH PLUG-IN POWER SUPPLY

One family two wires colour **EASYKIT Wifi with Netatmo** connected video kit with plug-in power supply and wall mounted entrance panel that can be easily adapted for two family houses. An external CCTV colour camera can be directly connected to the entrance panel. Wifi connected handsfree 7" screen internal unit white finish with European Plug-In power supply included. The system can be expanded up to 3 traditional handsfree internal units. Thanks to the Wifi connection, you can associate the video internal unit to the HOME + SECURITY App (available for Android and iOS).

You can manage by the App the main video internal unit functions (receiving calls, opening the door lock, view the cameras). Through the same App, it is also possible to manage the products of the Netatmo security range (outdoor and indoor cameras, door and window sensors, indoor siren and smoke detector).

This allows you to quickly and easily create a Smart security system.



### 7" MIRROR BLACK FINISH **EASYKIT PLUS**

#### WITH PLUG-IN POWER SUPPLY

One family two wires colour **EASYKIT Plus** video kit with plug-in power supply and wall mounted entrance panel that can be easily adapted for two family houses.

An external CCTV colour camera can be directly connected to the entrance panel. Handsfree 7" screen internal unit black finish mirror effect, with touch control commands for main functions and European Plug-In power supply included.

The system can be expanded up to 3 traditional handsfree internal units.



### 7" WHITE FINISH **EASYKIT ESSENTIAL**

#### WITH PLUG-IN POWER SUPPLY





One family two wires colour **EASYKIT Essential** video kit with plug-in power supply and wall mounted entrance panel that can be easily adapted for two family houses. An external CCTV colour camera can be directly connected to the entrance panel. Handsfree 7" screen internal unit white finish with touch control commands for main functions and European Plug-In power supply included.

The system can be expanded up to 3 traditional handsfree internal units.







PLUG-IN PWS (included)	EASYKIT Wifi with Netatmo	EASYKIT PLUS	EASYKIT ESSENTIAL
<b>European standard</b> 	<b>LG-360910</b> 7 inch white finish screen <b>Wifi with Netatmo KIT</b>	<b>LG-368910</b> 7 inch black finish screen <b>Plus KIT</b>	<b>LG-367910</b> 7 inch white finish screen <b>Essential kit</b>
	<b>LG-365220</b> 7 inch white finish <b>additional</b> <b>Wifi with Netatmo Internal unit</b>	<b>LG-364220</b> 7 inch black finish <b>additional Plus Internal unit</b>	<b>LG-363220</b> 7 inch white finish <b>additional</b> <b>Essential Internal unit</b>
<b>Video colour entrance panel</b> 	<b>LG-369339</b> (Additional colour entrance panel with rainshield)		
<b>Additional External camera</b> 	<b>LG-369401</b> (European standard PLUG Colour external camera)		
<b>Spare part Power supply</b> 	<b>BT-SP101</b> (Spare part plug-in power supply)		



**NOTE:** internal units are all compatible. As additional internal unit you can use any of the range.

# LEGRAND BRAND KITS

## EASYKIT with PLUG-IN POWER SUPPLY



LG-360910



LG-368910



LG-367910



LG-365220



LG-364220



LG-363220

Item	7" White finish <b>EASYKIT Wifi</b> with plug-in power supply
LG-360910	<p>One family two wires colour <b>EASYKIT Wifi connected video kit with plug-in power supply and wall mounted entrance panel</b>. Metal finish entrance panel with rainshield, colour wide angle camera and LED for the night illumination of the field of view. Entrance panel can be easily adapted for two family houses. An external CCTV colour camera can be directly connected to the entrance panel.</p> <p>Wifi connected handsfree 7" screen internal unit white finish with European PLUG-IN std power supply included. The system can be expanded up to 3 traditional handsfree internal units.</p> <p>Thanks to the Wifi connection, you can associate the video internal unit to the Home + Security App (available for Android and iOS). You can manage by the App the main video internal unit functions (receiving calls, opening the door lock, view the cameras). Through the same App, it is also possible to manage the products of the Netatmo security range (outdoor and indoor cameras, door and window sensors, indoor siren and smoke detector). This allows you to quickly and easily create a Smart security system.</p>
	<p><b>Additional video internal units</b></p>
LG-365220	<p><b>Additional EASYKIT Wifi connected handsfree 7" screen internal unit white finish</b> with EU standard plug-in power supply included. Touch control commands for main functions. Wall mounting installation. Thanks to the Wifi connection, you can associate the video internal unit to the Home + Security App (available for Android and iOS).</p>
LG-364220	<p><b>Additional EASYKIT Plus handsfree 7" screen internal unit black finish mirror effect</b> with EU standard plug-in power supply included. Touch control commands for main functions. Wall mounting installation.</p>
LG-363220	<p><b>Additional handsfree 7" EASYKIT Essential screen internal unit white finish</b> with EU standard plug-in power supply included. Touch control commands for main functions. Wall mounting installation.</p>

Item	7" Mirror black finish <b>EASYKIT Plus</b> with plug-in power supply
LG-368910	<p>One family two wires colour <b>EASYKIT Plus video kit with plug-in power supply and wall mounted entrance panel</b>. Metal finish entrance panel with rainshield, colour wide angle camera and LED for the night illumination of the field of view. Entrance panel can be easily adapted for two family houses. An external CCTV colour camera can be directly connected to the entrance panel.</p> <p>Handsfree 7" screen internal unit black finish mirror effect, with touch control commands for main functions and European PLUG-IN std power supply included. The system can be expanded up to 6 internal units (3 per entrance panel) and up to 2 entrance panels.</p>
LG-367910	<p><b>7" Mirror black finish EASYKIT Essential with plug-in power supply</b></p> <p>One family two wires colour <b>EASYKIT Essential video kit with plug-in power supply and wall mounted entrance panel</b>. Metal finish entrance panel with rainshield, colour wide angle camera and LED for the night illumination of the field of view. Entrance panel can be easily adapted for two family houses. An external CCTV colour camera can be directly connected to the entrance panel.</p> <p>Handsfree 7" screen internal unit white finish with touch control commands for main functions and European PLUG-IN std power supply included. The system can be expanded up to 6 internal units (3 per entrance panel) and up to 2 entrance panels.</p>



LG-369339



LG-369401



BT-SP101

### Wiring diagram example

**Item Additional video entrance panel with rainshield**

LG-369339 Additional video colour entrance panel with rainshield. Wide angle colour camera (105°). IP54 Protection degree.

**Additional external camera**

LG-369401 Additional external colour camera with coaxial video output, metal case and 3.6 mm fixed lens. Night vision. Power supply 100-240 Vac / 50-60 Hz (12 VDC Plug-in power supply with EU standard socket supplied). Degree of protection IP66 – degree of robustness IK07. Can be connected directly to the entrance panel.

**Plug-In power supply**

BT-SP101 Plug-In power supply with EU Standard plug. Nominal input voltage : 110 - 240 Vac @ 50/60 Hz. Output : 30 Vdc - 1 A. Integrated fuse on PRI side (F1 T2A 250 V).

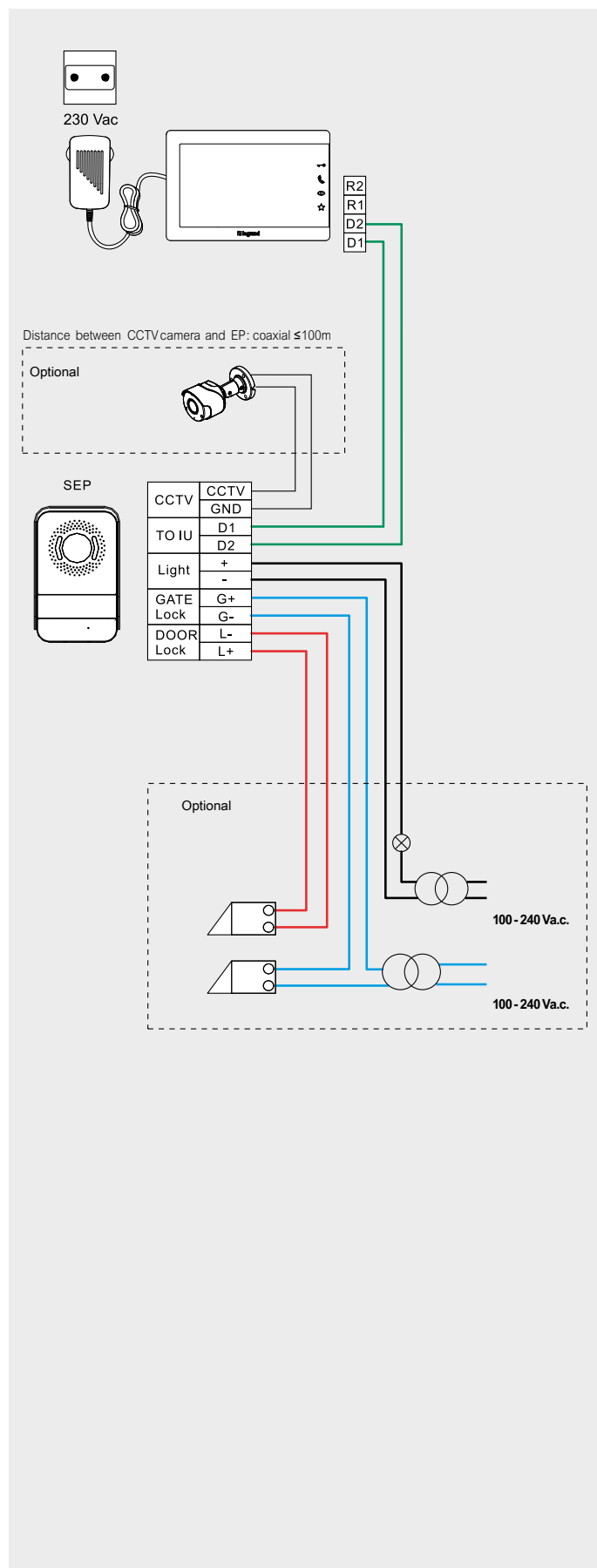

# EASYKIT

## WITH DIN POWER SUPPLY

2 WIRES



### 7" WHITE FINISH **EASYKIT Wifi with Netatmo** WITH DIN POWER SUPPLY

One family two wires colour **EASYKIT Wifi with Netatmo** connected video kit with 2-DIN modules power supply and wall mounted entrance panel that can be easily adapted for two family houses. An external CCTV colour camera can be directly connected to the entrance panel.

Wifi connected handsfree 7" screen internal unit white finish.

The system can be expanded up to 3 traditional handsfree internal units.

Thanks to the Wifi connection, you can associate the video internal unit to the HOME + SECURITY App (available for Android and iOS). You can manage by the App the main video internal unit functions (receiving calls, opening the door lock, view the cameras). Through the same App, it is also possible to manage the products of the Netatmo security range (outdoor and indoor cameras, door and window sensors, indoor siren and smoke detector).

This allows you to quickly and easily create a Smart security system.



### 7" MIRROR BLACK FINISH **EASYKIT PLUS** WITH DIN POWER SUPPLY

One family two wires colour **EASYKIT Plus** video kit with 2-DIN modules power supply and wall mounted entrance panel that can be easily adapted for two family houses. An external CCTV colour camera can be directly connected to the entrance panel. Handsfree 7" screen internal unit black finish mirror effect, with touch control commands for main functions.

The system can be expanded up to 3 traditional handsfree internal units.







### 7" WHITE FINISH **EASYKIT ESSENTIAL** WITH DIN POWER SUPPLY

One family two wires colour **EASYKIT Essential** video kit with 2-DIN modules power supply and wall mounted entrance panel that can be easily adapted for two family houses. An external CCTV colour camera can be directly connected to the entrance panel. Handsfree 7" screen internal unit white finish with touch control commands for main functions.

The system can be expanded up to 3 traditional handsfree internal units.

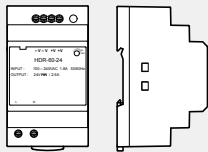



DIN power supply (included)	EASYKIT Wifi with Netatmo	EASYKIT PLUS	EASYKIT ESSENTIAL
	<p><b>LG-360915</b> 7" inch white finish screen <b>Wifi with Netatmo KIT</b></p> <p><b>LG-365225</b> 7" inch white finish <b>additional</b> <b>Wifi with Netatmo Internal unit</b></p>	<p><b>LG-368915</b> 7" inch black finish screen <b>Plus KIT</b></p> <p><b>LG-364225</b> 7" inch black finish <b>additional Plus Internal unit</b></p>	<p><b>LG-367915</b> 7" inch white finish screen <b>Essential kit</b></p> <p><b>LG-363225</b> 7" inch white finish <b>additional</b> <b>Essential Internal unit</b></p>
<p><b>Video colour entrance panel</b></p> 	<p><b>LG-369339</b> (Additional colour entrance panel with rainshield)</p>		
<p><b>Additional External camera</b></p> 	<p><b>LG-369401</b> (European standard PLUG Colour external camera)</p>		
<p><b>Spare part Power supply</b></p> 	<p><b>BT-SP102</b> (2-DIN Spare part power supply)</p>		



**NOTE:** internal units are all compatible. As additional internal unit you can use any of the range.



# LEGRAND BRAND KITS

## EASYKIT with DIN POWER SUPPLY



LG-360915



LG-368915



LG-367915



LG-365225



LG-364225



LG-363225

**Item** **7" White finish EASYKIT Wifi with DIN power supply**

**LG-360915** One family two wires colour **EASYKIT Wifi connected video kit with DIN power supply and wall mounted entrance panel**. Metal finish entrance panel with rainshield, colour wide angle camera and LED for the night illumination of the field of view. Entrance panel can be easily adapted for two family houses. An external CCTV colour camera can be directly connected to the entrance panel.

Wifi connected handsfree 7" screen internal unit white finish with 2 DIN modules power supply included. The system can be expanded up to 3 traditional handsfree internal units.

Thanks to the Wifi connection, you can associate the video internal unit to the Home + Security App (available for Android and iOS). You can manage by the App the main video internal unit functions (receiving calls, opening the door lock, view the cameras). Through the same App, it is also possible to manage the products of the Netatmo security range (outdoor and indoor cameras, door and window sensors, indoor siren and smoke detector). This allows you to quickly and easily create a Smart security system.

**Additional video internal units**

**LG-365225** **Additional EASYKIT Wifi connected handsfree 7" screen internal unit in white finish**. Touch control commands for main functions. Wall mounting installation. Thanks to the Wifi connection, you can associate the video internal unit to the Home + Security App (available for Android and iOS).

**LG-364225** **Additional EASYKIT Plus handsfree 7" screen internal unit black finish mirror effect**. Touch control commands for main functions. Wall mounting installation.

**LG-363225** **Additional handsfree 7" EASYKIT Essential screen internal unit white finish**. Touch control commands for main functions. Wall mounting installation.

**Item** **7" Mirror black finish EASYKIT Plus with DIN power supply**

**LG-368915** One family two wires colour **EASYKIT Plus video kit with DIN power supply and wall mounted entrance panel**. Metal finish entrance panel with rainshield, colour wide angle camera and LED for the night illumination of the field of view. Entrance panel can be easily adapted for two family houses. An external CCTV colour camera can be directly connected to the entrance panel.

Handsfree 7" screen internal unit black finish mirror effect, with touch control commands for main functions and DIN power supply included. The system can be expanded up to 6 internal units (3 per entrance panel) and up to 2 entrance panels.

**Item** **7" Mirror black finish EASYKIT Essential with DIN power supply**

**LG-367915** One family two wires colour **EASYKIT Essential video kit with DIN power supply and wall mounted entrance panel**. Metal finish entrance panel with rainshield, colour wide angle camera and LED for the night illumination of the field of view. Entrance panel can be easily adapted for two family houses. An external CCTV colour camera can be directly connected to the entrance panel.

Handsfree 7" screen internal unit white finish with touch control commands for main functions and DIN power supply included. The system can be expanded up to 6 internal units (3 per entrance panel) and up to 2 entrance panels.



LG-369339



LG-369401



BT-SP102

### Wiring diagram example

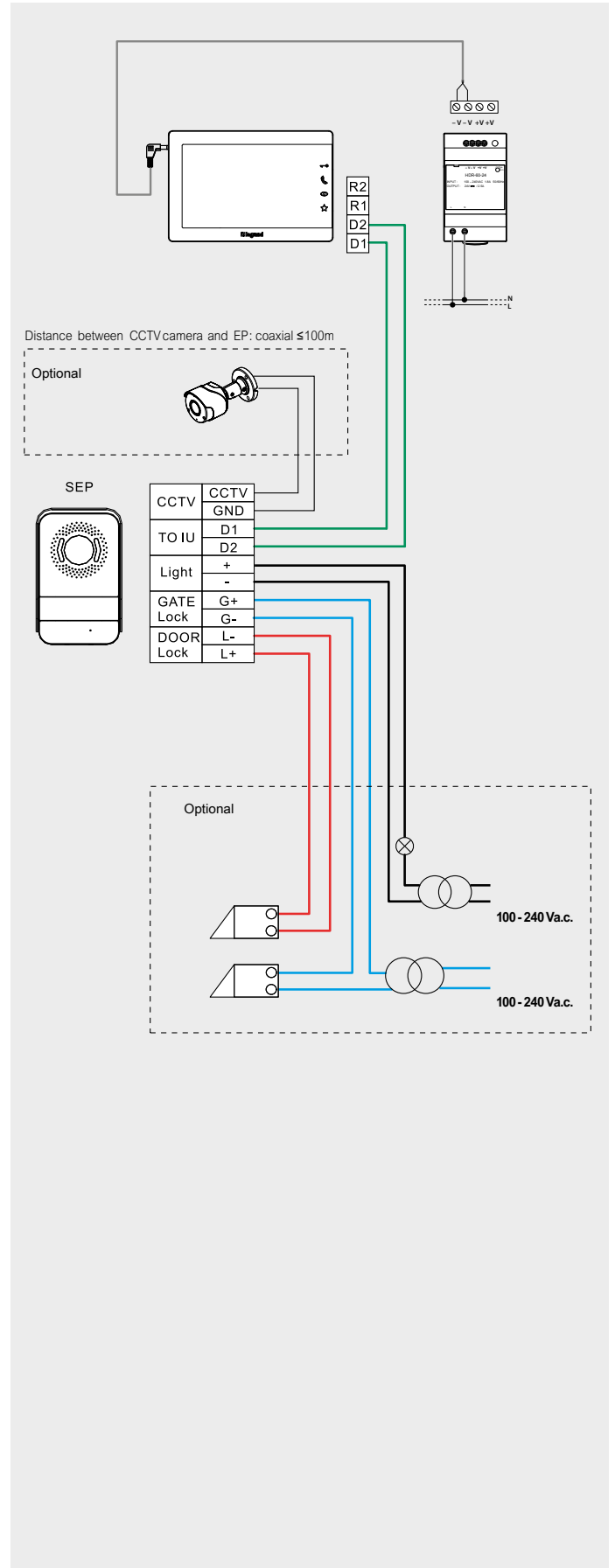

**Item Additional video entrance panel with rainshield**

LG-369339 Additional video colour entrance panel with rainshield. Wide angle colour camera (105°). IP54 Protection degree.

**Additional external camera**

BT-369401 Additional external colour camera with coaxial video output, metal case and 3.6 mm fixed lens. Night vision. Power supply 100-240 Vac / 50-60 Hz (12 VDC Plug-in power supply with EU standard socket supplied). Degree of protection IP66 – degree of robustness IK07. Can be connected directly to the entrance panel.

**Plug-In power supply**

BT-SP102 2 DIN module power supply. Nominal input voltage : 85 - 264 Vac @ 50/60 Hz. Output: 24 Vdc - 2.5 A. It must only be installed indoors and only in switchboards set up for DIN devices. Use an omnipolar switch with separation between the contacts of at least 3 mm positioned near the power supply.

# WIRING DIAGRAM EXAMPLES

2 WIRES

## Example 1 - SINGLE FAMILY SYSTEM WITH ONE ENTRANCE PANEL & PLUG-IN POWER SUPPLY

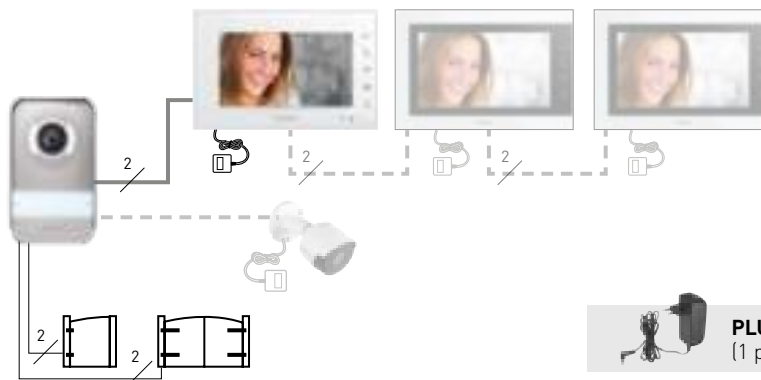

**PLUG-IN power supply**  
(1 power supply for each monitor)

## Example 2 - SINGLE FAMILY SYSTEM WITH TWO ENTRANCE PANELS & DIN POWER SUPPLY

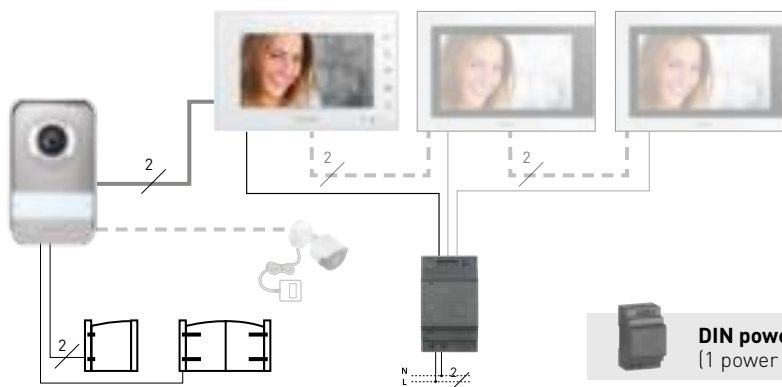

**DIN power supply**  
(1 power supply for the entire system)

**Example 3 - TWO-FAMILY SYSTEM WITH PLUG-IN POWER SUPPLY**

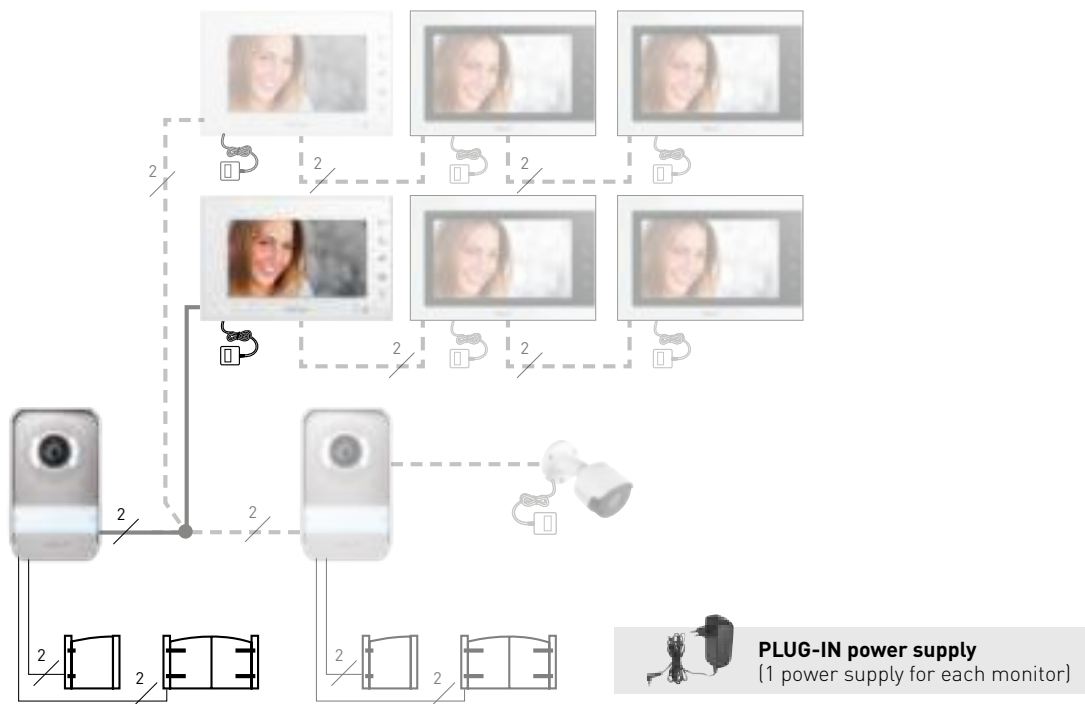

**NOTE:** if necessary, to control the electrical door lock release, use DIN transformer BT-336842 (230 Va.c.)

**Example 4 - TWO-FAMILY SYSTEM WITH DIN POWER SUPPLY**

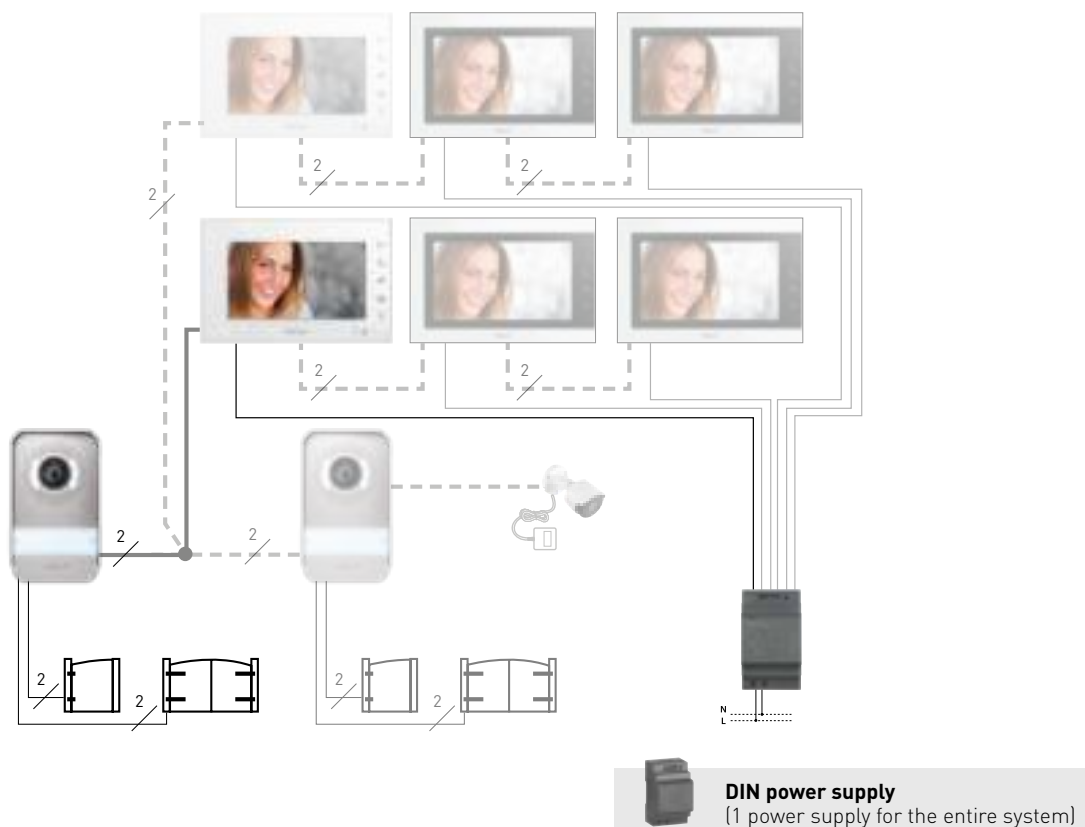

**NOTE:** if necessary, to control the electrical door lock release, use DIN transformer BT-336842 (230 Va.c.)

## BTICINO BRAND KITS



### 7" COLOUR VIDEO KITS

#### 7" HANDS-FREE AND HANDSET VIDEO KITS

One-family 4-wires colour video **hands-free and handset kits**, wall mounted with internal power supply, expandable up to 4 additional internal units and up to 1 additional entrance panel or a CCTV camera, offering the basic door entry system functions: call, intercom, door lock activation, image cycling. Composed of a hands-free or handset internal unit, with a 7" colour display and 12 ringtones, signaling LED and MUTE function; and a discrete Zamak entrance panel with rain-shield, microphone and speaker volume adjustments, colour camera and LED for enhancing lighting in the visual field.



### 4.3" COLOUR VIDEO KITS

#### 4.3" HANDS-FREE AND HANDSET VIDEO KITS

One-family 4-wires colour video **hands-free and handset kits**, wall mounted with internal power supply, expandable up to 4 additional internal units and up to 1 additional entrance panel or a CCTV camera, offering the basic door entry system functions: call, intercom, door lock activation, image cycling. Composed of a hands-free or handset internal unit, with a 4.3" colour display and 12 ringtones, signaling LED and MUTE function; and a discrete Zamak entrance panel with rain-shield, microphone and speaker volume adjustments, colour camera and LED for enhancing lighting in the visual field.



### HANDSET AUDIO KIT

One-family 4-wires handset audio kit, wall mounted with internal power supply, expandable up to 4 additional internal units, offering the basic door entry system functions: call, intercom, door lock activation. Composed of a handset audio internal unit, signaling LED and MUTE function; and a discrete Zamak entrance panel with rain-shield, microphone and speaker volume adjustments.





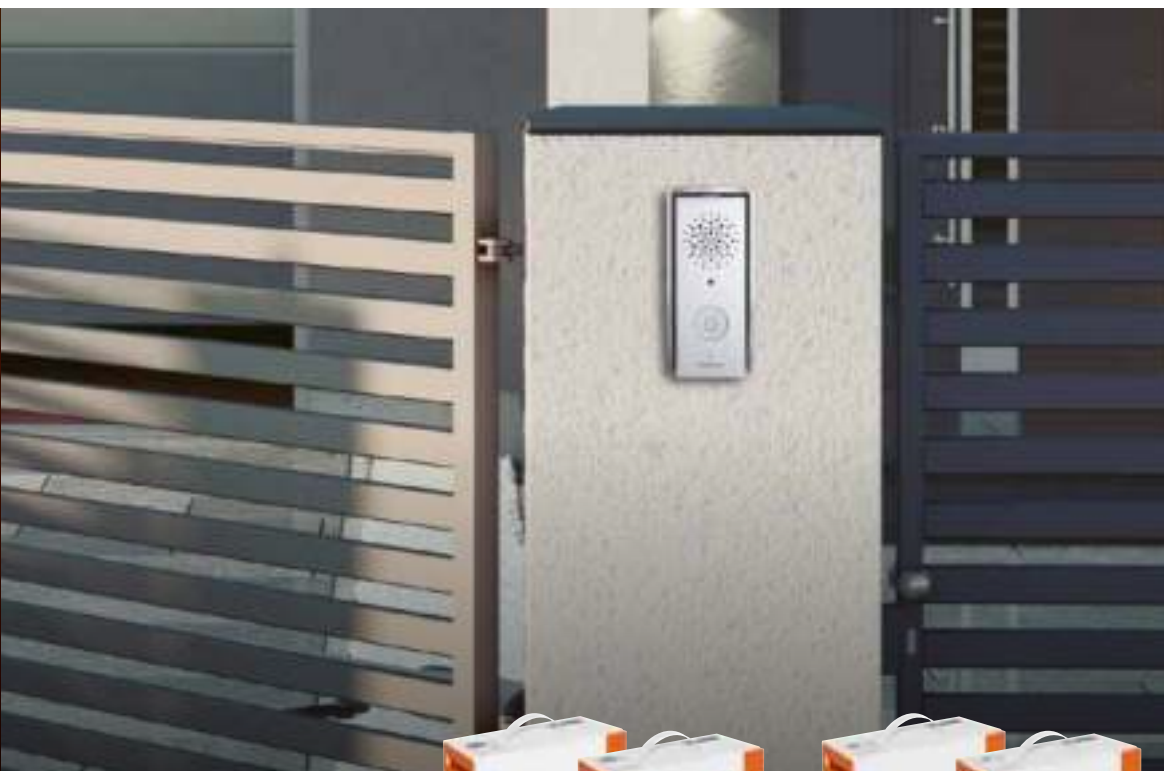

	7" VIDEO KITS	4.3" VIDEO KITS	AUDIO KIT
<b>Kit</b> 	<b>BT-315511</b> (7" Hands-free kit) <b>BT-315411</b> (7" Handset kit)	<b>BT-315311</b> (4.3" Hands-free kit) <b>BT-315211</b> (4.3" Handset kit)	<b>BT-315111</b> (Handset kit)
<b>Additional internal units</b> 	<b>BT-330851</b> (Additional 7" Handsfree internal unit) <b>BT-330751</b> (Additional 7" Handset internal unit)	<b>BT-330651</b> (Additional 4.3" Handsfree internal unit) <b>BT-330551</b> (Additional 4.3" Handset internal unit)	<b>BT-330451</b> (Additional audio handset)
<b>NOTE: internal units are all compatible. As additional internal unit you can use any of the range.</b>			
<b>Additional entrance panels</b> 	<b>BT-330560</b> (Additional video entrance panel with rainshield) <b>BT-330460</b> (Additional audio entrance panel with rainshield) <b>BT-330660</b> (Entrance panel angle bracket accessory)		
<b>Additional external cameras</b> 	<b>BT-391441</b> (Additional external camera – European standard)		

# BTICINO BRAND KITS

## BASIC KITS



BT-315511



BT-315411



BT-315311



BT-315211



BT-315111

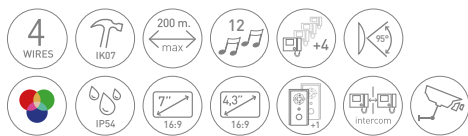

### Item 7" Video kits

ONE-FAMILY 4-wires colour video hands-free or handset kit, wall mounted with internal power supply, expandable up to 4 additional Internal Units and up to 1 additional External Panel or an External Camera (NTSC or PAL), offering the following functions: call, intercom, door lock activation, image cycling. Composed of a hands-free or a handset Video Internal Unit, with a 7" colour display and 12 ringtones, signaling LED and MUTE function; and a discrete Zamak Entrance Panel, with rain-shield, microphone and speaker volume adjustments, colour camera and LED for enhancing lighting in the visual field.

BT-315511 7" Hands-free video kit

BT-315411 7" Handset video kit

### 4.3" Video kits

ONE-FAMILY 4-wires colour video hands-free or handset kit, wall mounted with internal power supply, expandable up to 4 additional Internal Units and up to 1 additional External Panel or an External Camera (NTSC or PAL), offering the following functions: call, intercom, door lock activation, image cycling. Composed of a hands-free or a handset Video Internal Unit, with a 4,3" colour display, signaling LED and MUTE function; and a discrete Zamak Entrance Panel, with rain-shield, microphone and speaker volume adjustments, colour camera and LED for enhancing lighting in the visual field.

BT-315311 4.3" Hands-free video kit

BT-315211 4.3" Handset video kit

### Item Audio kit

ONE-FAMILY 3-wires handset Audio kit, wall mounted with internal power supply, expandable up to 4 additional Internal Units, offering the following functions: call, intercom, door lock activation. Composed of a handset Audio Internal Unit, signaling LED and MUTE function; and a discrete Zamak Entrance Panel with rain-shield, microphone and speaker volume adjustments.

BT-315111 Handset audio kit

**Item Additional 7" Video Internal Units**

BT-330851 Colour video hands-free additional Internal Unit, recommended to expand a ONE FAMILY BASIC 4-wires Video Kit, wall mounted with internal power supply, a 7" colour display and 12 ringtones, signaling LED and MUTE function, offering the following functions: call, intercom, door lock activation, image cycling.

BT-330751 Colour video handset additional internal unit, recommended to expand a ONE FAMILY BASIC 4-wires Video Kit, wall mounted with internal power supply, a 7" colour display and 12 ringtones, signaling LED and MUTE function, offering the following functions: call, intercom, door lock activation, image cycling.

**Additional 4.3" Video Internal Units**

BT-330651 Colour video hands-free additional Internal Unit, recommended to expand a ONE FAMILY BASIC 4-wires Video Kit, wall mounted with internal power supply, a 4,3" colour display and 12 ringtones, signaling LED and MUTE function, offering the following functions: call, intercom, door lock activation, image cycling.

BT-330551 Colour video handset additional Internal Unit, recommended to expand a ONE FAMILY BASIC 4-wires Video Kit, wall mounted with internal power supply, a 4,3" colour display and 12 ringtones, signaling LED and MUTE function, offering the following functions: call, intercom, door lock activation, image cycling.

**Additional Audio handset Internal Unit**

BT-330451 Audio handset additional Internal Unit, recommended to expand ONE FAMILY BASIC Video or Audio Kit, wall mounted with internal power supply, signaling LED and MUTE function, offering the following functions: call, intercom and door lock activation.

**Item Additional Video Entrance Panel**

BT-330560 Additional Zamak Entrance Panel, recommended to expand a ONE FAMILY BASIC 4-wires Video Kit, wall mounted with embedded rain-shield, microphone and speaker volume adjustments, colour camera and LED for enhancing lighting in the visual field.

**Additional Audio Entrance Panel**

BT-330460 Additional Zamak Entrance Panel, recommended to expand a ONE FAMILY BASIC Audio or Video Kit, wall mounted with embedded rain-shield, microphone and speaker volume adjustments.

**Angle Bracket accessory**

BT-330660 Accessory for the installation of the External Panels BT-330560 - BT-330460 to adjust its visual field by a 30°-angle, to the right or to the left.

**Additional External Camera**

External colour camera, IP66 Protection Degree, PAL video system, with plug-in power supply included.

BT-391441 European standard plug version

## BASIC

**4 WIRES**



### 7" COLOUR VIDEO KITS

#### 7" HANDS-FREE AND HANDSET VIDEO KITS

One-family 4-wires colour video **hands-free and handset kits**, wall mounted with internal power supply, expandable up to 4 additional internal units and up to 1 additional entrance panel or a CCTV camera, offering the basic door entry system functions: call, intercom, door lock activation, image cycling. Composed of a hands-free or handset internal unit, with a 7" colour display and 12 ringtones, signaling LED and MUTE function; and a discrete Zamak entrance panel with rain-shield, microphone and speaker volume adjustments, colour camera and LED for enhancing lighting in the visual field.



### 4.3" COLOUR VIDEO KITS

#### 4.3" HANDS-FREE AND HANDSET VIDEO KITS

One-family 4-wires colour video **hands-free and handset kits**, wall mounted with internal power supply, expandable up to 4 additional internal units and up to 1 additional entrance panel or a CCTV camera, offering the basic door entry system functions: call, intercom, door lock activation, image cycling. Composed of a hands-free or handset internal unit, with a 4.3" colour display and 12 ringtones, signaling LED and MUTE function; and a discrete Zamak entrance panel with rain-shield, microphone and speaker volume adjustments, colour camera and LED for enhancing lighting in the visual field.







### HANDSET AUDIO KIT

One-family 4-wires handset audio kit, wall mounted with internal power supply, expandable up to 4 additional internal units, offering the basic door entry system functions: call, intercom, door lock activation. Composed of a handset audio internal unit, signaling LED and MUTE function; and a discrete Zamak entrance panel with rain-shield, microphone and speaker volume adjustments.





	7" VIDEO KITS	4.3" VIDEO KITS	AUDIO KIT
<b>Kit</b> 	<b>LG-369580</b> (7" Hands-free kit) <b>LG-369570</b> (7" Handset kit)	<b>LG-369560</b> (4.3" Hands-free kit) <b>LG-369550</b> (4.3" Handset kit)	<b>LG-369500</b> (Handset kit)
<b>Additional internal units</b> 	<b>LG-369585</b> (7" Hands-free additional video internal unit) <b>LG-369575</b> (7" Handset additional video internal unit)	<b>LG-369565</b> (4.3" Hands-free additional video internal unit) <b>LG-369555</b> (4.3" Handset additional video internal unit)	<b>LG-369505</b> (Handset additional audio internal unit)
<b>NOTE: internal units are all compatible. As additional internal unit you can use any of the range.</b>			
<b>Additional entrance panels</b> 	<b>LG-369596</b> (Additional video entrance panel with rainshield) <b>LG-369595</b> (Additional audio entrance panel with rainshield) <b>LG-369597</b> (Entrance panel angle bracket accessory)		
<b>Additional external cameras</b> 	<b>LG-369401</b> (Additional external camera – European standard)		





# LEGRAND BRAND KITS

## BASIC KITS



LG-369580

LG-369570

LG-369560

LG-369550

LG-369500

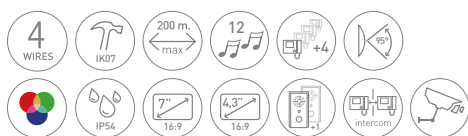

**Item** **7" Video kits**  
 ONE-FAMILY 4-wires colour video hands-free or handset kit, wall mounted with internal power supply, expandable up to 4 additional Internal Units and up to 1 additional External Panel or an External Camera (NTSC or PAL), offering the following functions: call, intercom, door lock activation, image cycling. Composed of a hands-free or a handset Video Internal Unit, with a 7" colour display and 12 ringtones, signaling LED and MUTE function; and a discrete Zamak Entrance Panel, with rain-shield, microphone and speaker volume adjustments, colour camera and LED for enhancing lighting in the visual field.

LG-369580 7" Hands-free video kit

LG-369570 7" Handset video kit

**4.3" Video kits**  
 ONE-FAMILY 4-wires colour video hands-free or handset kit, wall mounted with internal power supply, expandable up to 4 additional Internal Units and up to 1 additional External Panel or an External Camera (NTSC or PAL), offering the following functions: call, intercom, door lock activation, image cycling. Composed of a hands-free or a handset Video Internal Unit, with a 4,3" colour display, signaling LED and MUTE function; and a discrete Zamak Entrance Panel, with rain-shield, microphone and speaker volume adjustments, colour camera and LED for enhancing lighting in the visual field.

LG-369560 4.3" Hands-free video kit

LG-369550 4.3" Handset video kit

**Item** **Audio kit**  
 ONE-FAMILY 3-wires handset Audio kit, wall mounted with internal power supply, expandable up to 4 additional Internal Units, offering the following functions: call, intercom, door lock activation. Composed of a handset Audio Internal Unit, signaling LED and MUTE function; and a discrete Zamak Entrance Panel with rain-shield, microphone and speaker volume adjustments.

LG-369500 Handset audio kit



**Item Additional 7" Internal Units**

**LG-369585** Colour video hands-free additional Internal Unit, recommended to expand a ONE FAMILY BASIC 4-wires Video Kit, wall mounted with internal power supply, a 7" colour display and 12 ringtones, signaling LED and MUTE function, an External Camera (NTSC or PAL), offering the following functions: call, intercom, door lock activation, image cycling.

**LG-369575** Colour video handset additional internal unit, recommended to expand a ONE FAMILY BASIC 4-wires Video Kit, wall mounted with internal power supply, a 7" colour display and 12 ringtones, signaling LED and MUTE function, an External Camera (NTSC or PAL), offering the following functions: call, intercom, door lock activation, image cycling.

**Additional 4.3" Internal Units**

**LG-369565** Colour video hands-free additional Internal Unit, recommended to expand a ONE FAMILY BASIC 4-wires Video Kit, wall mounted with internal power supply, a 4,3" colour display and 12 ringtones, signaling LED and MUTE function, an External Camera (NTSC or PAL), offering the following functions: call, intercom, door lock activation, image cycling.

**LG-369555** Colour video handset additional Internal Unit, recommended to expand a ONE FAMILY BASIC 4-wires Video Kit, wall mounted with internal power supply, a 4,3" colour display and 12 ringtones, signaling LED and MUTE function, an External Camera (NTSC or PAL), offering the following functions: call, intercom, door lock activation, image cycling.

**Additional audio handset Internal Unit**

**LG-369505** Audio handset additional Internal Unit, recommended to expand ONE FAMILY BASIC Video or Audio Kit, wall mounted with internal power supply, signaling LED and MUTE function, offering the following functions: call, intercom and door lock activation.

**Item Additional video Entrance Panel**

**LG-369596** Additional Zamak Entrance Panel, recommended to expand a ONE FAMILY BASIC 4-wires Video Kit, wall mounted with embedded rain-shield, microphone and speaker volume adjustments, colour camera and LED for enhancing lighting in the visual field.

**Additional audio Entrance Panel**

**LG-369595** Additional Zamak Entrance Panel, recommended to expand a ONE FAMILY BASIC Audio or Video Kit, wall mounted with embedded rain-shield, microphone and speaker volume adjustments

**Angle bracket accessory**

**LG-369597** Accessory for the installation of the External Panels LG-369596 - LG-369595 to adjust its visual field by a 30°-angle, to the right or to the left.

**Additional External Camera**

External colour camera, IP66 Protection Degree, PAL video system, with plug-in power supply included.

**LG-369401** European standard plug version

# WIRING DIAGRAM EXAMPLES

**4 WIRES**

## Example 1 - SINGLE FAMILY STANDARD VIDEO SYSTEM

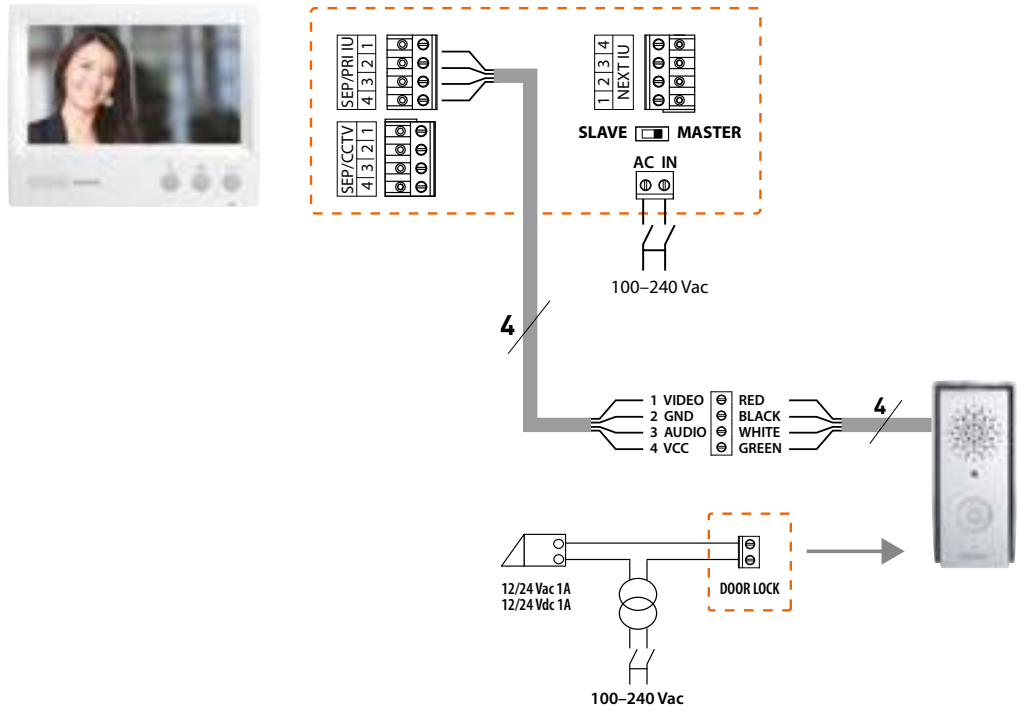

## Example 2 - SINGLE FAMILY STANDARD AUDIO SYSTEM

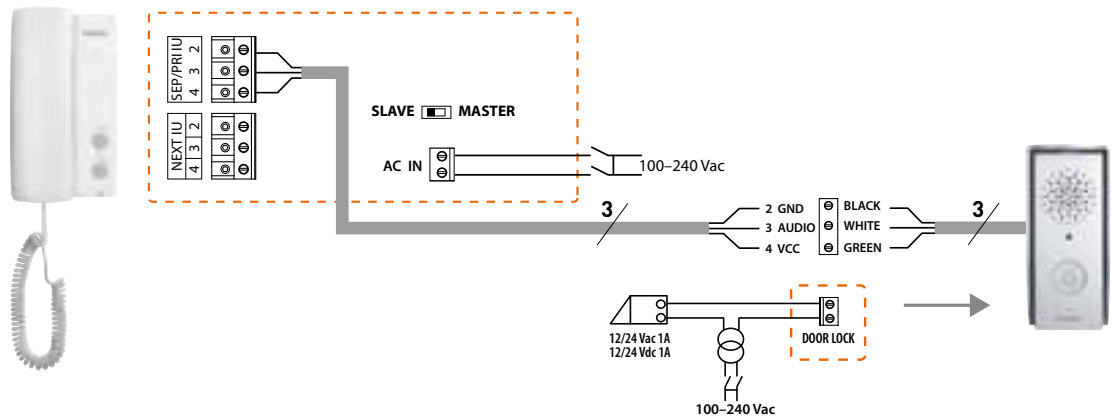

**Example 3 - SINGLE FAMILY VIDEO SYSTEM – MAXIMUM EXPANSION WITH CAMERA**

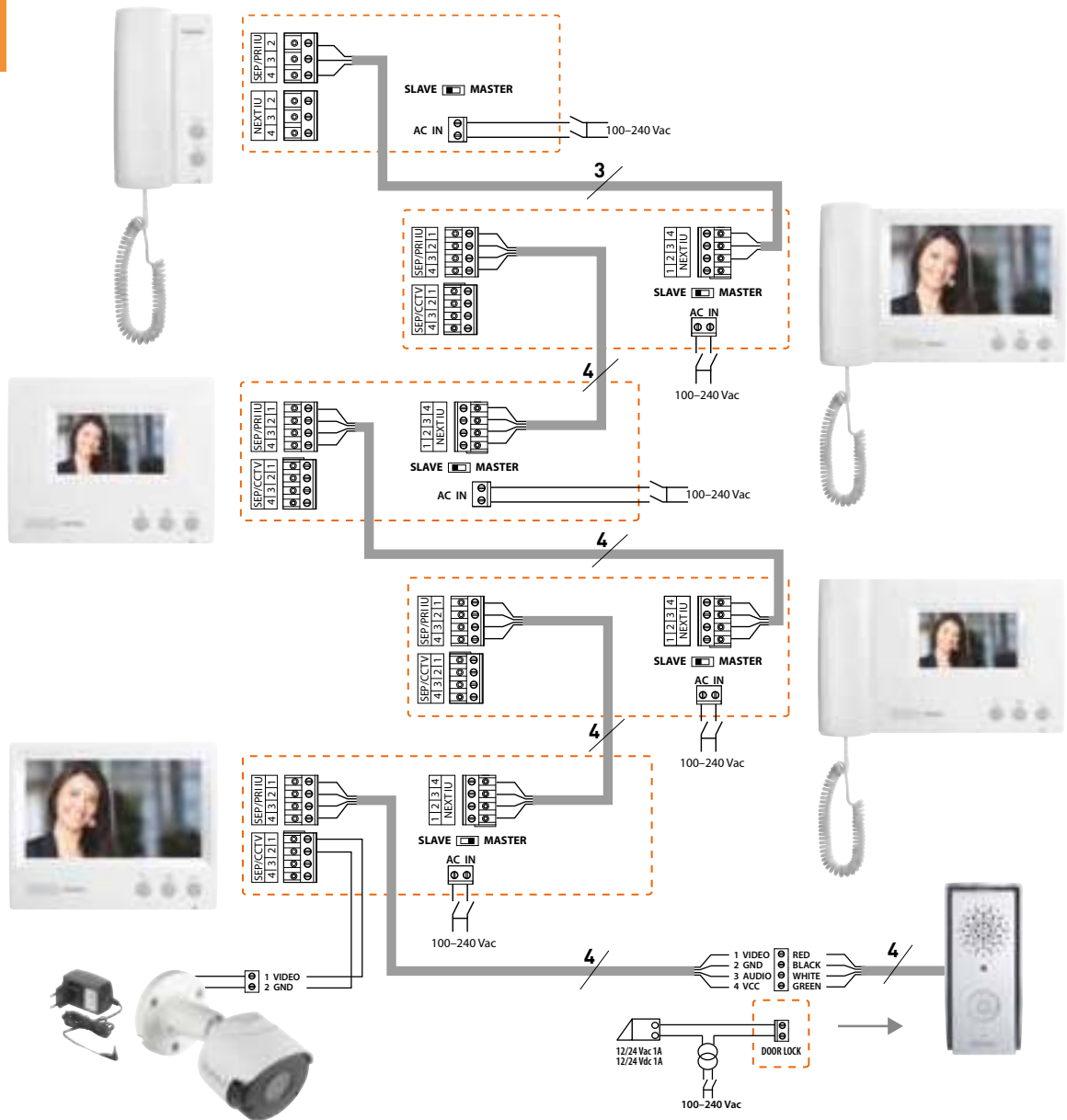

# PROFESSIONAL KITS



- The 2-wires technology allows maximum flexibility and expandability
- From basic functions to advanced functions such as call redirection on smartphone, video door entry answering machine, Netatmo cameras integration, intercom and door opening with badge
- Modular DIN-rail power supply
- Include a manual with all the technical information required for the installation, connection, features and expansion possibilities.



## SUITABLE FOR VILLA STANDARD - HIGH LEVEL APPLICATIONS



Call redirection  
on smartphone



**CLASSE 300E0S**







**2 WIRES**

FULL EXPANDIBILITY

**EXPANSION**

Expand these kits with other devices such as additional entrance panels, internal units, cameras, and home automation devices.



**AUDIO  
KITS**



**VIDEO  
KITS**



**NETATMO**  
Smart Outdoor  
camera



**LINEA 3000**

Door opening  
with badge



# PROFESSIONAL KITS

## MAXIMUM SIMPLICITY

The 2 Wires professional kits guarantee maximum simplicity and flexibility of installation. They are the ideal solution for making new systems and in renovations.

Both audio and video systems require only 2 WIRES for the installation, so that existing wires can be used in the renovations.

There is no need to respect polarity in the connections, giving maximum simplification in the installation work.

### LINEA 3000 - One family audio Kit – installation example



**ONE**  
FAMILY HOUSE

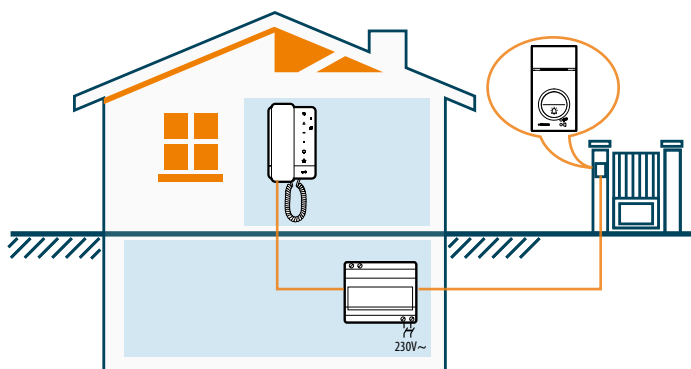

#### ONE FAMILY AUDIO KIT 364231

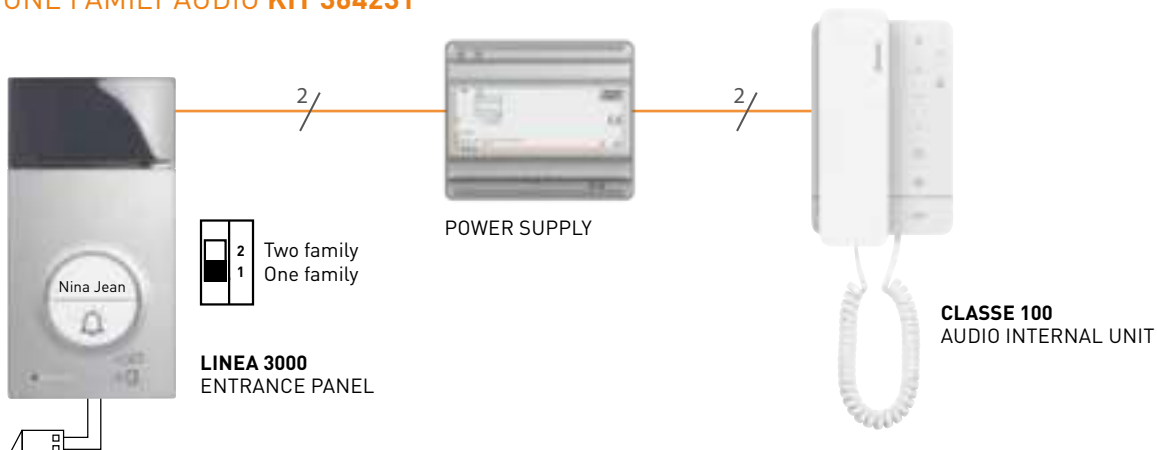

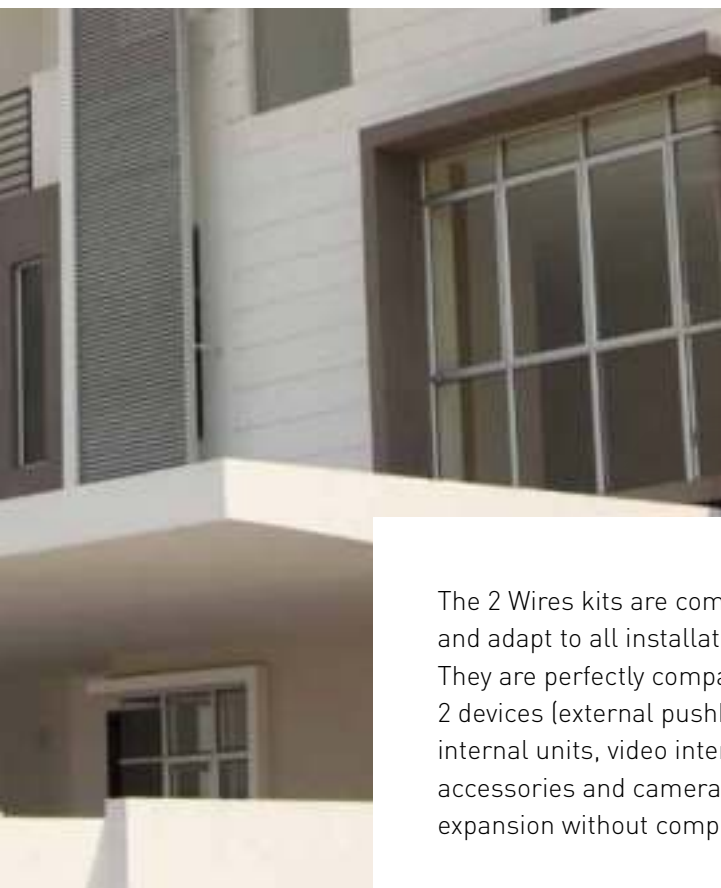

VIDEO KIT

AUDIO KIT

The 2 Wires kits are completely expandable and adapt to all installation needs. They are perfectly compatible with the 2 devices (external pushbutton panels, internal units, video internal units, system accessories and cameras), allowing expansion without compromises.

**LINEA 3000 - Two family video Kit – installation example**

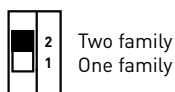
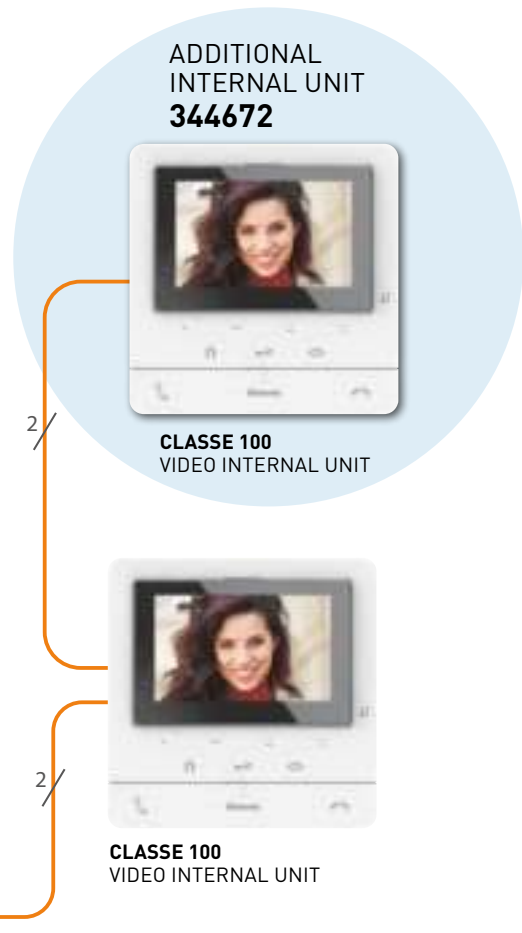
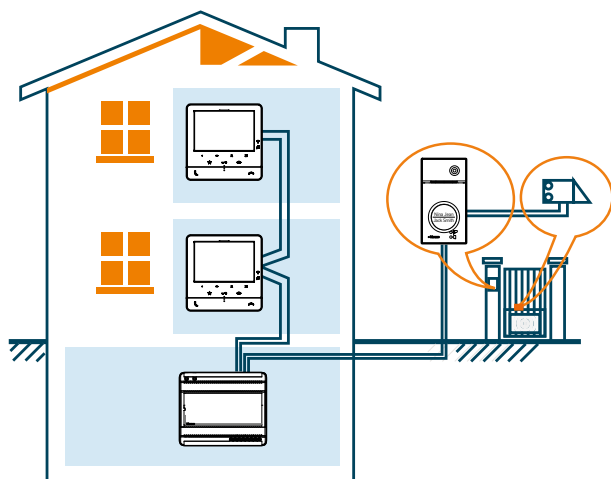

LINEA 3000 ENTRANCE PANEL

POWER SUPPLY



CLASSE 100 VIDEO INTERNAL UNIT

# PROFESSIONAL KITS

## VILLA CONNECTED VIDEO KITS



363950

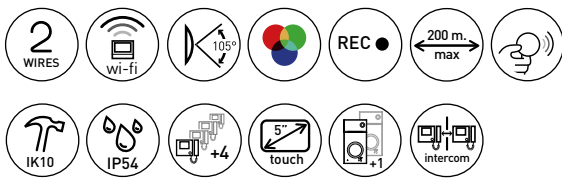

Item

### CLASSE 300EOS - LINEA 3000 - Netatmo smart outdoor camera connected kit

One-family kit with Classe 300EOS handsfree connected video internal unit, LINEA 3000 pushbutton panel in black finish and Netatmo Smart Outdoor Camera.

2 wires/Wi-Fi handsfree connected video internal unit with Teleloop, built-in Amazon Alexa voice assistant, 5" vertical touch screen LCD display and video door entry answering machine. Easy interaction with the built-in Alexa voice assistant, either using the dedicated capacitive keys or with your voice, and activate several functions, such as the video door entry functions, Smart Home, scenarios, reminders etc. Thanks to the Wi-Fi connectivity, you can associate the video internal unit to the Home + Security App (available for Android and iOS). The App allows to use the main video internal unit functions (receiving calls, door lock release, display of the event timeline and activation of the entrance panel/camera cycling). With the Home + Security App, it is also possible to manage the products of Netatmo security range (outdoor and indoor cameras, door and window sensors, indoor siren, smoke detector). This allows you to quickly and easily create a Smart security system. The device also allows to create and manage Smart Home functions, using the wired SCS BUS solution or the Zigbee solution, without the need for adding dedicated gateways. LINEA 3000 pushbutton panel with black finish zamak front cover, wide angle colour camera and proximity reader and with a kit of coloured key cards and two clear discs for door lock release. Can be wall or flush installed with specific accessories: (350020) flush mounted box and (343063) flush mounted accessory - to be purchased separately. Can be fitted with rainshield (343053) - to be purchased separately. The pushbutton panel has a protection index IP54- protection index against mechanical impact IK10. Smart Outdoor Security Camera with LED lighting spotlight, night vision and motion detection – send real time notification on smartphone in case of unknown person or vehicle detection.

363950

### Complete one family kit

(Easy switch to two families system by purchasing an additional internal unit - refer to 2 Wires system internal units range).

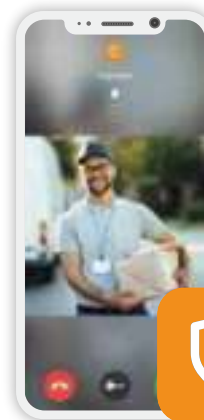

**HOME + SECURITY** is the App that allows, through the smartphone, to manage calls locally and remotely of the video door phone or with a simple touch to open the gate, the activation of the cameras, and switching on of the timed lights in the garden. Allows you to activate and view images of Netatmo Smart Outdoor and Indoor Cameras. Setting up the App requires a few steps and thanks to the BTicino Cloud, the remote connection is fully automated and managed with the highest level of security.

Item	Kit composition	Qty
343093	LINEA 3000 pushbutton panel	1
344842	CLASSE 300EOS video internal unit	1
NOC-PRO	Smart Outdoor Camera	1
346050	6 DIN SCS power supply	1
346250	Door lock relay accessory	1
348260	Set of coloured door lock release key cards	1
348261	Set of door lock release clear discs	1





363915

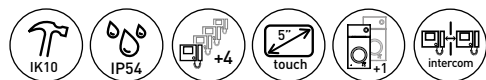

**CLASSE 300EOS WITH NETATMO – LINEA 3000 connected video kit**

One family handsfree kit with Classe 300EOS with Netatmo handsfree connected video internal unit and LINEA 3000 pushbutton panel in black finish. 2 wires/Wi Fi handsfree connected video internal unit with built in Amazon Alexa voice assistant, 5" vertical touch screen LCD display and video door entry answering machine. It is possible to easily interact with the built in Alexa voice assistant, either using the dedicated capacitive keys or with your voice, and activate several functions, such as the video door entry functions, Smart Home, scenarios, reminders etc. Thanks to the Wi Fi connectivity, you can associate the video internal unit to the Home + Security App (available for Android and iOS). The App allows to use the main video internal unit functions (receiving calls, door lock release, display of the event timeline and activation of the entrance panel/camera cycling). With the Home + Security App, it is also possible to manage the products of the Netatmo security range (outdoor and indoor cameras, door and window sensors, indoor siren, smoke detector). This allows you to quickly and easily create a Smart security system. The device also allows to create and manage MyHOME functions, using the wired SCS BUS solution. LINEA 3000 pushbutton panel with black finish zamak front cover, wide angle colour camera and proximity reader and with a kit of coloured key cards and two clear discs for door lock release. Can be wall or flush installed with specific accessories: (350020) flush mounted box and (343063) flush mounted accessory to be purchased separately. Can be fitted with rainshield (343053) to be purchased separately. The pushbutton panel has a protection index IP54 protection index against mechanical impact IK10.

**Complete one family kit**

(Easy switch to two families system by purchasing an additional internal unit - refer to 2 Wires system internal units range).

363915

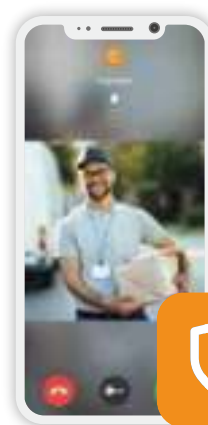

**HOME + SECURITY** is the App that allows, through the smartphone, to manage calls locally and remotely of the video door phone or with a simple touch to open the gate, the activation of the cameras, and switching on of the timed lights in the garden. Allows you to activate and view images of Netatmo Smart Outdoor and Indoor Cameras. Setting up the App requires a few steps and thanks to the BTicino Cloud, the remote connection is fully automated and managed with the highest level of security.

Item	Kit composition	Qty
343093	LINEA 3000 pushbutton panel	1
344842	CLASSE 300EOS video internal unit (white finish)	1
346050	6 DIN SCS power supply	1
346250	Door lock relay accessory	1
348260	Set of coloured door lock release key cards	1
348261	Set of door lock release clear discs	1



# PROFESSIONAL KITS

## VILLA CONNECTED VIDEO KITS



363926

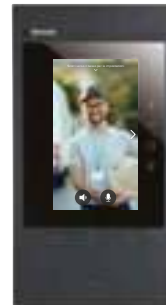

344884

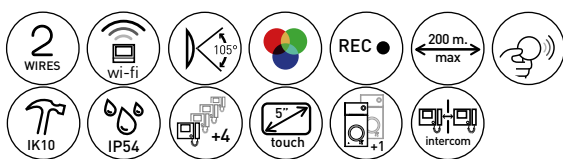

Item **CLASSE 300EOS WITH NETATMO- LINEA 3000 - Connected video Kit**

One-family handsfree kit with Classe 300EOS with Netatmo handsfree connected video internal unit and LINEA 3000 pushbutton panel in black finish. 2 wires/Wi-Fi handsfree connected video internal unit with built-in Amazon Alexa voice assistant, 5" vertical touch screen LCD display and video door entry answering machine. It is possible to easily interact with the built-in Alexa voice assistant, either using the dedicated capacitive keys or with your voice, and activate several functions, such as the video door entry functions, Smart Home, scenarios, reminders etc. Thanks to the Wi-Fi connectivity, you can associate the video internal unit to the Home + Security App (available for Android and iOS). The App allows to use the main video internal unit functions (receiving calls, door lock release, display of the event timeline and activation of the entrance panel/camera cycling). With the Home + Security App, it is also possible to manage the products of the Netatmo security range (outdoor and indoor cameras, door and window sensors, indoor siren, smoke detector). This allows you to quickly and easily create a Smart security system. The device also allows to create and manage MyHOME functions, using the wired SCS BUS solution. LINEA 3000 pushbutton panel with black finish zamak front cover, wide angle colour camera and proximity reader and with a kit of coloured key cards and two clear discs for door lock release. Can be wall or flush installed with specific accessories: (350020) flush mounted box and (343063) flush mounted accessory - to be purchased separately. Can be fitted with rainshield (343053) - to be purchased separately. The pushbutton panel has a protection index IP54-protection index against mechanical impact IK10.

363926 **Complete one family kit**

(Easy switch to two families system by purchasing an additional internal unit - refer to 2 Wires system internal units range).

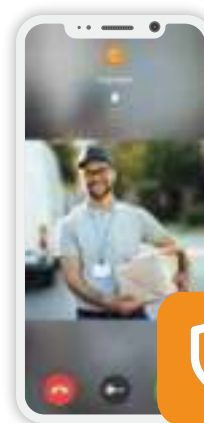

**HOME + SECURITY** is the App that allows, through the smartphone, to manage calls locally and remotely of the video door phone or with a simple touch to open the gate, the activation of the cameras, and switching on of the timed lights in the garden. Allows you to activate and view images of Netatmo Smart Outdoor and Indoor Cameras. Setting up the App requires a few steps and thanks to the BTicino Cloud, the remote connection is fully automated and managed with the highest level of security.

Item	Kit composition	Qty
343093	LINEA 3000 pushbutton panel	1
344884	CLASSE 300EOS video internal unit (black finish)	1
346050	6 DIN SCS power supply	1
346250	Door lock relay accessory	1
348260	Set of coloured door lock release key cards	1
348261	Set of door lock release clear discs	1



364614

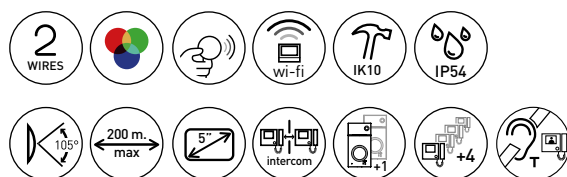

**Item CLASSE 100X16E - LINEA 3000 connected video kit**

One-family handsfree kit with: Classe 100X16E with Netatmo Wifi video internal unit, handsfree function, inductive loop, 5" LCD display; LINEA 3000 pushbutton panel with zamak front cover, wide angle colour camera, proximity reader and with a set of coloured key cards and two clear discs for door lock release. Can be configured for one-family and two-family installations. Nameplate lit by white LED. Can be wall or flush installed with specific accessories: (350020) flush mounted box and (343061) flush mounted accessory - to be purchased separately. Can be fitted with rainshield (343051)- to be purchased separately. The pushbutton panel has a protection index IP54- protection index against mechanical impact IK10. The video internal unit has 4.3" colour LCD display and Inductive Loop function (to enable use by people wearing hearing aids fitted with T selector). It also has 3 touch keys for the control of the main functions – door lock release, staircase light control and entrance panel activation/scrolling – there are further 4 configurable touch keys that perform different functions – e.g. staircase light control, intercom, additional door lock activation, generic activations. It has a side lever to adjust: colour, brightness and display contrast, audio volume, call tone volume and Wi-Fi configuration. There are call exclusion notification LEDs and Wifi. Also, thanks to the Wifi connection, you can associate the video internal unit to the Home + Security App (available for Android and iOS). Through the Home + Security App it is also possible to manage the products of Netatmo security offer (Outdoor and Indoor cameras, door and window sensors, internal siren and smoke detector). The installation can be made to the wall using the bracket supplied or using table support accessories (2 x 344692) – to be purchased separately. The device, also equipped with the professional studio (office) function, must be configured.

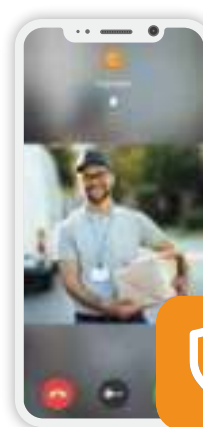

**HOME + SECURITY** is the App that allows, through the smartphone, to manage calls locally and remotely of the video door phone or with a simple touch to open the gate, the activation of the cameras, and switching on of the timed lights in the garden. Allows you to activate and view images of Netatmo Smart Outdoor and Indoor Cameras. Setting up the App requires a few steps and thanks to the BTicino Cloud, the remote connection is fully automated and managed with the highest level of security.

Item	Kit composition	Qty
343093	LINEA 3000 pushbutton panel	1
344682	CLASSE 100X16E video internal unit	1
346050	6 DIN SCS power supply	1
346250	Door lock relay accessory	1
348260	Set of coloured door lock release key cards	1
348261	Set of door lock release clear discs	1

**364614 Complete one family kit**

(Easy switch to two families system by purchasing an additional internal unit - refer to 2 Wires system internal units range).

# PROFESSIONAL KITS

## VILLA VIDEO KITS



364612

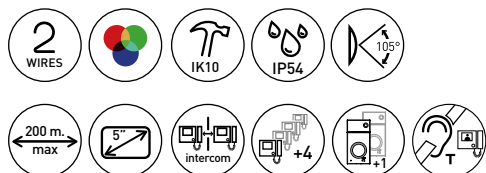

Item **CLASSE 100V16E - LINEA 3000 video kit**

One-family handsfree kit with CLASSE 100V16E video indoor unit and LINEA 3000 pushbutton panel with zamak front cover and wide angle colour camera. Can be configured for one-family or two-family installations. Nameplate lit by white LED. Can be wall or flush installed with specific accessories: (350020) flush mounted box with (343061) flush mounted accessory - to be purchased separately. Can be fitted with rainshield (343051) – to be purchased separately.

The pushbutton panel has a protection index IP54 - protection index against mechanical impact IK10. The video indoor unit has 5" LCD display and Inductive Loop function (to enable use by people wearing hearing aids fitted with T selector). It has 2 physical keys for the control of the main functions – answer and end a call – and has 3 touch keys for the control of the main functions – door lock release, staircase light control and entrance panel activation/scrolling – there are further 4 configurable touch keys that perform different functions – e.g. intercom, additional door lock activation, generic activations. Wall mounted installation with the bracket supplied or table installation with support accessories (2 x 344692) - to be purchased separately.

The device also has Professional Studio (Office) function and must be configured.

364612 **Complete one family kit**

(Easy switch to two families system by purchasing an additional internal unit - refer to 2 Wires system internal units range).

Item	Kit composition	Qty
343081	LINEA 3000 Entrance panel	1
344672	CLASSE 100V16E Video internal unit	1
346050	6 DIN System power supply	1
346250	Relay module accessory	1



364613

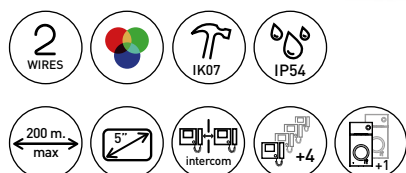

364622

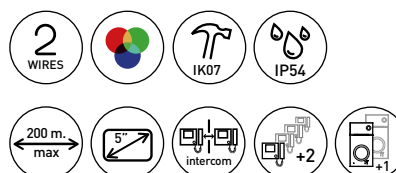
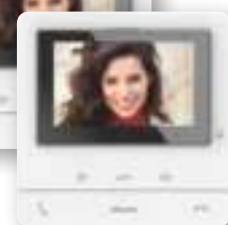
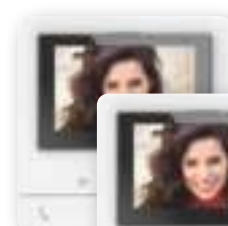

**Item CLASSE 100V16E - LINEA 2000 video kit**

364613 One-family handsfree video kit consisting of: CLASSE 100V16B video indoor unit, LINEA 2000 pushbutton panel with colour camera and 1 call pushbutton. The push-button panel has a protection index against mechanical impact IK07 and protection index IP54. The video indoor unit has 2 physical keys for the control of the main video door entry functions – answer and end a call – and 3 touch keys that allow the door lock release, the entrance panel activation/scrolling and the customization of a most frequently used quick action – e.g. staircase light control, intercom, additional door lock activation, generic activations. The video indoor unit has a 5" colour LCD display and a side lever to adjust: colour, brightness and display contrast, audio and call tone volume. There is a call exclusion notification LED. Wall mounted installation with the bracket supplied or table installation with support accessories (2 x 344692) - to be purchased separately.

**Item CLASSE 100V16B - LINEA 2000 video kit**

364622 Two-families handsfree video kit consisting of: CLASSE 100V16B video indoor units, LINEA 2000 pushbutton panel with colour camera and 2 call pushbuttons. The push-button panel has a protection index against mechanical impact IK07 and protection index IP54. The video indoor units has 2 physical keys for the control of the main video door entry functions – answer and end a call – and 3 touch keys that allow the door lock release, the entrance panel activation/scrolling and the customization of a most frequently used quick action – e.g. staircase light control, intercom, additional door lock activation, generic activations. The video indoor units has a 5" colour LCD display and a side lever to adjust: colour, brightness and display contrast, audio and call tone volume. There is a call exclusion notification LED. Wall mounted installation with the bracket supplied or table installation with support accessories (2 x 344692) - to be purchased separately.

Item	Kit composition	Qty
343031	LINEA 2000 Entrance panel - 1 CALL	1
344652	CLASSE 100V16B Video internal unit	1
346050	6 DIN System power supply	1
346250	Relay module accessory	1

Item	Kit composition	Qty
343032	LINEA 2000 Entrance panel - 2 CALLS	1
344652	CLASSE 100V16B Video internal unit	2
346050	6 DIN System power supply	1
346250	Relay module accessory	1

# PROFESSIONAL KITS

## VILLA AUDIO KITS



364232



364231

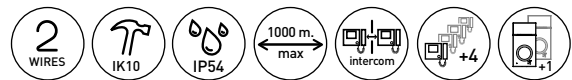
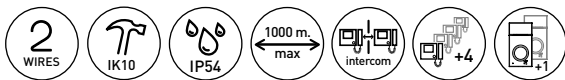

Item	CLASSE 100A16E - LINEA 3000 hands free audio kit
364232	One-family handsfree kit with CLASSE 100A16E audio indoor unit and LINEA 3000 pushbutton panel with zamak front cover. Can be configured for one-family or two-family installations. Nameplate lit by white LED. Can be wall or flush installed with specific accessories: (350020) flush mounted box with (343061) flush mounted accessory - to be purchased separately. Can be fitted with rainshield (343051) – to be purchased separately. The pushbutton panel has a protection index IP54 – protection index against mechanical impact IK10. The indoor unit has 2 physical keys for the control of the main door entry functions – answer and end a call – and has 3 touch keys for the control of the main functions – door lock release, staircase light control and entrance panel activation/scrolling – there are further 4 configurable touch keys that perform different functions – e.g. intercom, additional door lock activation, generic activations. Ringtone volume adjustment (with call exclusion) using the appropriate selector. The installation can be made to the wall using the bracket supplied or using table support accessory (1 x 344692) – to be purchased separately. The device also has Professional Studio (Office) function and must be configured.

Item	CLASSE 100A16M - LINEA 3000 AUDIO kit with hand set
364231	One-family audio kit with CLASSE 100A16M audio indoor unit and LINEA 3000 pushbutton panel with zamak front cover. Can be configured for one-family or two-family installations. Nameplate lit by white LED. Can be wall or flush installed with specific accessories: (350020) flush mounted box with (343061) flush mounted accessory – to be purchased separately. Can be fitted with rainshield (343051) – to be purchased separately. The pushbutton panel has a protection index IP54 – protection index against mechanical impact IK10. The audio indoor unit has 3 touch keys for the control of the main functions – door lock release, staircase light control and entrance panel activation/scrolling – there are further 4 configurable touch keys that perform different functions – e.g. intercom, additional door lock activation, generic activations. Ringtone volume adjustment (with call exclusion) using the appropriate selector. The installation can be made to the wall using the bracket supplied or using table support accessory (1 x 344692) – to be purchased separately. The device also has Professional Studio (Office) function and must be configured.

Item	Kit composition	Qty
343071	LINEA 3000 Audio entrance panel	1
344282	CLASSE 100A16E Audio internal unit	1
346040	6 DIN System power supply	1

Item	Kit composition	Qty
343071	LINEA 3000 Audio entrance panel	1
344292	CLASSE 100A16M Audio internal unit	1
346040	6 DIN System power supply	1





366811

366821



Item	<b>SPRINT L2 – LINEA 2000 AUDIO handset audio kit</b>
	Audio kit with audio handset SPRINT L2 and LINEA 2000 pushbutton panel. 2 WIRE technology. The audio handset has a door lock release pushbutton and a pushbutton that can be configured for auxiliary functions (staircase light switching on, entrance panel activation, call to the switchboard). Devices suitable for wall mounted installation. Expandable with additional audio handset 344242.
366811	Complete one-family kit
366821	Complete two-family kit

Item	Kit composition	366811	366821
		Qty	Qty
342911	LINEA 2000 Entrance panel - 1 CALL	1	-
342921	LINEA 2000 Entrance panel - 2 CALLS	-	1
344232	SPRINT L2 audio handset	1	2
346040	6 DIN System power supply	1	1



364211

Item	<b>Audio handsfree - LINEA 2000</b>
364211	One-family expandable audio kit with audio handsfree internal unit and LINEA 2000 pushbutton panel. The audio internal unit can manage with (1 – 2) pushbuttons on board two independent contacts (24 Vac/dc – 1 A max.) Entrance panel and internal unit are suitable for wall mounted installation. Expansion possibility using the specific additional handsfree internal unit 331650

Item	Kit composition	Qty
342911	LINEA 2000 Entrance panel - 1 CALL	1
331650	Audio handsfree internal unit	1
346040	6 DIN System power supply	1

# PROFESSIONAL KITS

## ANALOGUE KITS

### Audio Kits



363211



Item	<b>SPRINT - LINEA 2000 AUDIO KIT handset audio kit</b>
	Kit with SPRINT handset and LINEA 2000 pushbutton panel, aluminium finish. Devices suitable for wall mounted installation.
363211	Complete one-family kit
363221	Complete two-family kit

Item	Kit composition	363211	363221
		Qty	Qty
-	LINEA 2000 Entrance panel - 1 CALL	1	-
-	LINEA 2000 Entrance panel - 2 CALLS	-	1
334202	SPRINT Audio handset	1	2
336000	6 DIN System power supply	1	1

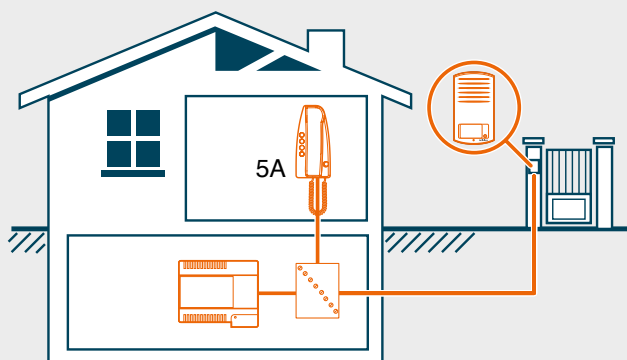

**ONE FAMILY AUDIO SYSTEM**

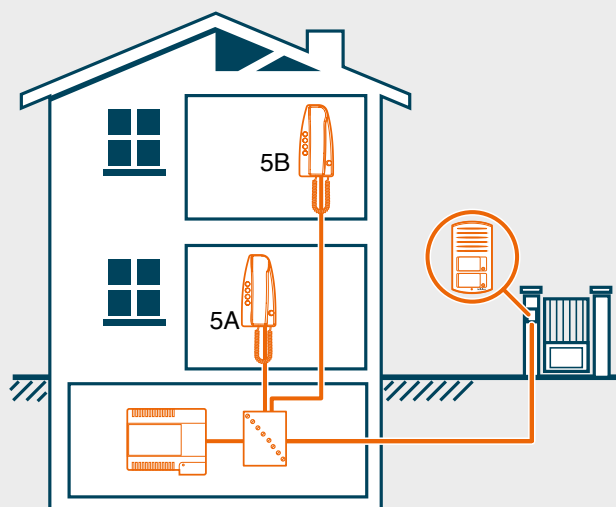

**TWO FAMILIES AUDIO SYSTEM**



363811



Item	<b>SPRINT - LINEA 2000 AUDIO handset kit</b>
363811	One-family kit with SPRINT handset and LINEA 2000 pushbutton panel. Analogue technology with 2 wire connection. Devices suitable for wall mounted installation. Expansion possibility using the specific additional handset 331550

Item	Kit composition	Qty
-	LINEA 2000 Entrance panel	1
-	SPRINT audio handset	1
336842	2 DIN Transformer	1
<b>Accessories</b>		
331550	Specific additional audio handset	

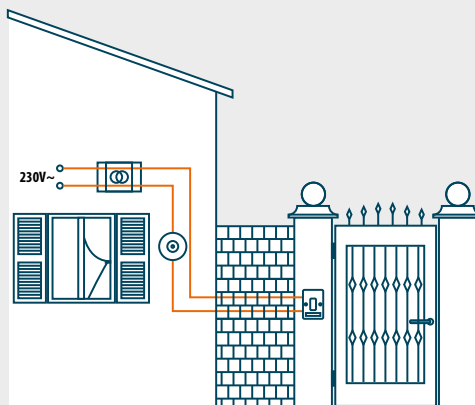

**OLD BELL SYSTEM**

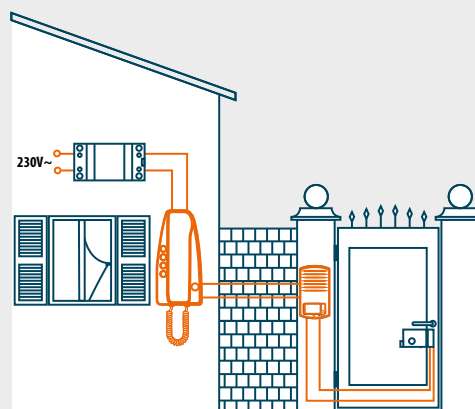

**NEW AUDIO SYSTEM**

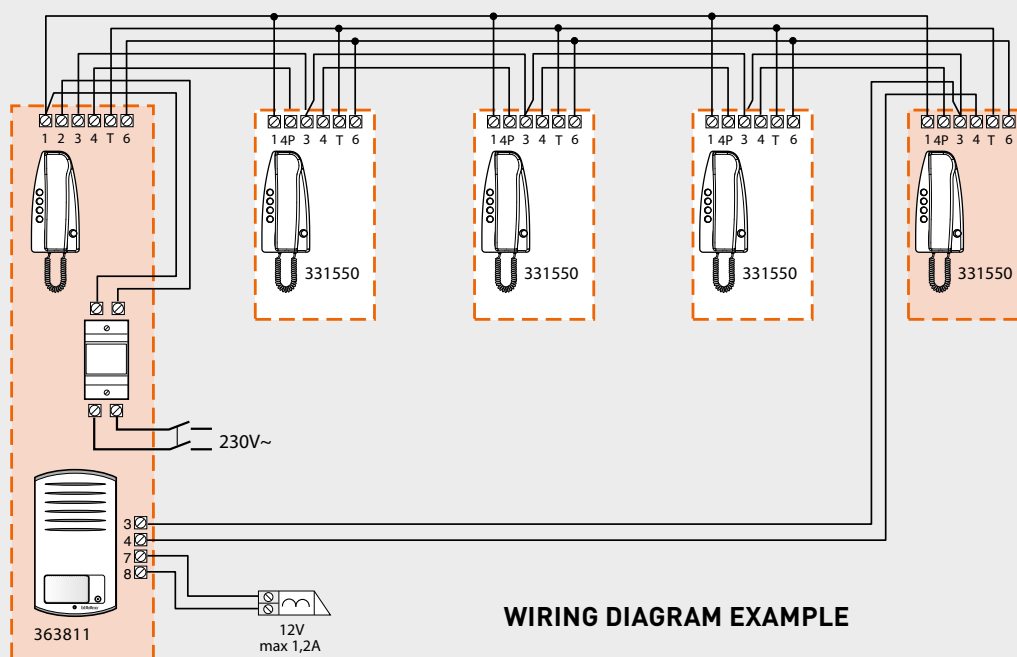

**WIRING DIAGRAM EXAMPLE**

# 2 WIRES SYSTEM

## The easiest system offer

The **2 WIRES SYSTEM** is the best technology for those cases when **time saving** and **ease of installation** are crucial. Thanks to the non polarized 2 wires system it is in fact possible to install, with the same ease, all kinds of systems, from those for single villas to those for apartment complexes.

This technology is particularly suitable, for example, for:

### SMALL AND MEDIUM SIZE SYSTEM



THE VILLA

### RENOVATIONS



The possibility of using existing cables makes it the ideal solution when refurbishing systems.



THE APARTMENT



Remove the old entrance panel being replaced.

Use the two cables already present to connect the new entrance panel.



In addition to the extreme simplicity, the system offers **VERY GOOD PERFORMANCE**

<b>SYSTEM MAIN FEATURES</b>	3900	Apartments
	3900	Apartment video entrance panels
	39	Risers with independent sound mode
	5	Handsets per apartment
	600 m	Distance between entrance panel and farthest internal unit

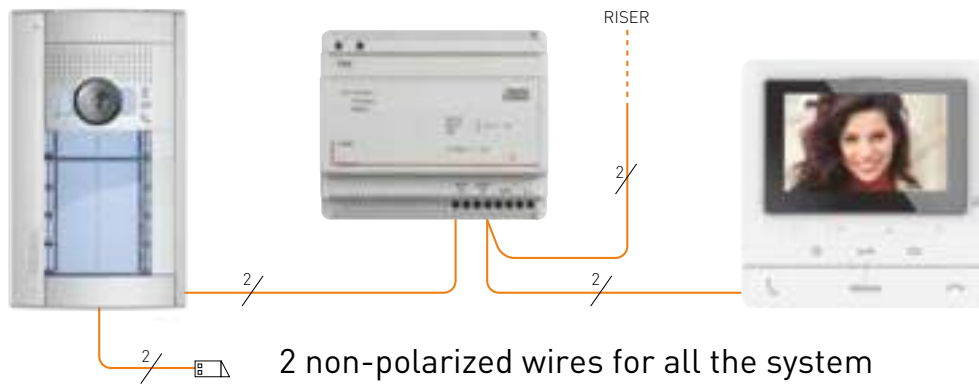

# THE 2 WIRES SYSTEM

offers a wide range of entrance panels and internal units, to meet all the customer needs.



# THE SYSTEM COMPOSITION

 2 WIRES



■ Thanks to the use of accessory devices, additional door locks can be **activated and/or lights switched on**.

A few accessory devices are needed to make the **2-WIRE systems**, as well as the entrance panels and the internal units and/or video internal units.



## AUDIO DOOR ENTRY SYSTEM

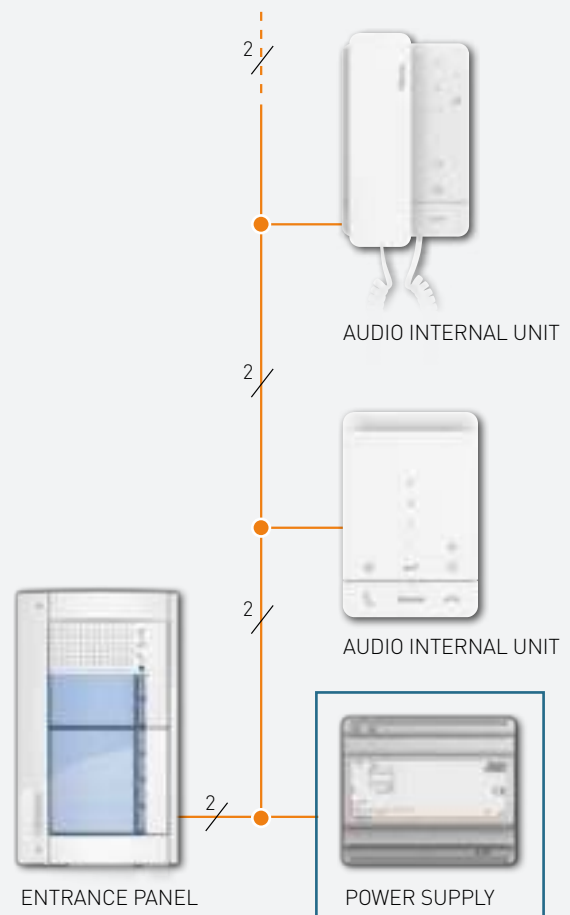



■ In apartment-block systems the switchboard can be used for **the management and centralised supervision** of the apartment-block services.

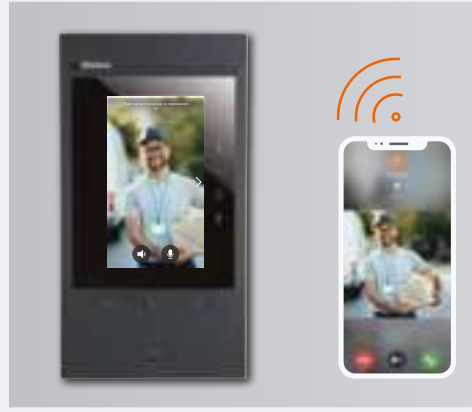

■ In systems with Classe 300EOS / Classe 100X16E connected internal units, you can **manage your door entry system calls and functions with your smartphone** thanks to the dedicated Home + Security App and with you voice (C300EOS only).



## VIDEO DOOR ENTRY SYSTEM

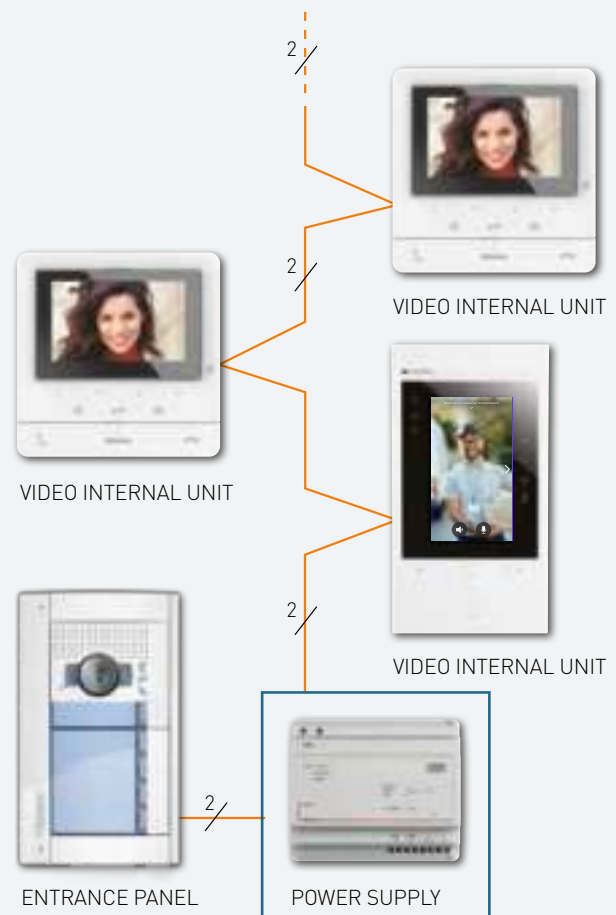



# ENTRANCE PANELS RANGE

- > LINEA SFERA
- > LINEA 3000
- > LINEA 2000
- > LINEA 100
- > LINEA 300



**LINEA 3000**



**LINEA 2000**



**LINEA 300**



**LINEA 100**



**SFERA NEW**



**SFERA ROBUR**

## 2 WIRES SYSTEM

### ENTRANCE PANELS

Overview and features

	Linea Sfera New	Linea Sfera Robur	Linea 3000
			
Audio	●	●	●
Colour video	●	●	●
Finishes / Colours	Allmetal Allwhite Allstreet	Zamak Robur	Zamak grey Zamak black
Wall mounted installation	●	●	●
Flush mounted installation	●	●	●
Pushbutton call	●	●	●
Digital call	●	●	
Wide angle camera (1)	●	●	●
Night & Day camera (2)	●	●	
Control speech synthesis (3)	●	●	
Door lock release with keypad	●	●	
Door lock release with key card	●	●	●
Rainshield	●	●	●
Vandal proof			
Protection index	IP54	IP54	IP54
Sturdiness index	Up to IK08	IK10	IK10
Max. number of calls	100 with pushbuttons 4000 with digital call	100 with pushbuttons 4000 with digital call	2

(1) Horizontal and vertical wide viewing field. Easy to use for children and differently-abled people.

(2) Night lighting thanks to the IR LED with automatic IR filter. Sharp, perfect images even in limited light conditions.

(3) Inductive loop and control speech synthesis. Use by people wearing hearing aids. Easy to use for visually impaired people.





Linea 2000	Linea 300	Linea 100
		
●		●
●	●	
Aluminium	Stainless Steel Aluminium	Stainless Steel
●	●	●
	●	
●	●	●
		●
		●
		●
IP54	IP54	IP44
IK07	IK07	IK08
2 (up to 4 calls - audio version only)	32 with pushbuttons 4000 with digital call	8 with pushbuttons 4000 with digital call

2 WIRES SYSTEM  
ENTRANCE PANEL  
SFERA

# TWO STYLES ONE ELECTRONIC HEART

## 2-wires simplicity, maximum performance

Exceptional audio and video performance as well as fast and simple installation can be achieved with 2-wires technology.

- Up to 4000 dwellings
- 20 handsets per dwelling
- Up to 96 video entrance panels
- Operable range of 600 m between entrance panel and internal unit

SFERA ROBUR



SFERA NEW



## 2 DESIGNS



### SFERA NEW

A modern and sleek design suitable for residential and commercial developments.



Audio or video pushbutton entrance panel

Call from address book



### SFERA ROBUR

Sturdy materials and optional flush-mounting boxes providing increased safety and preventing removal of the device.



Audio or video pushbutton entrance panel

Digital call



## 12 FUNCTIONS

### TRADITIONAL



### ADVANCED













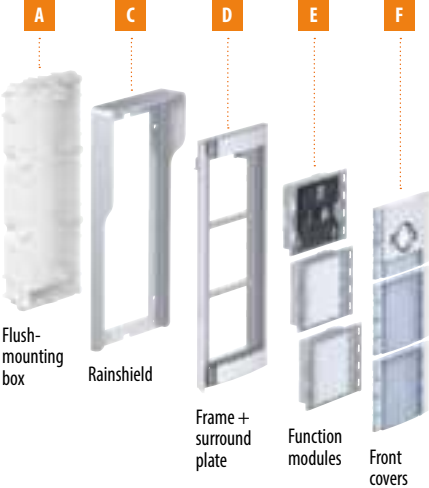











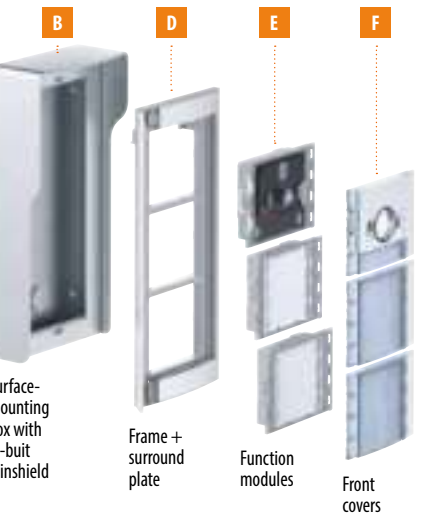

### DOOR LOCK RELEASE



# 2 WIRES SYSTEM













































## SFERA NEW

Examples to select parts of the system

Finishes	Installation type	Flush-mounting boxes		Rainshields (optional)		Frames/plates		
		Cat.Nos	Pack	Cat.Nos	Pack	Cat.Nos	Pack	
<b>ALLMETAL (SILVER)</b>  <b>1</b>	<b>FLUSH-MOUNTING INSTALLATION</b> 	<b>A</b>		<b>C</b>		<b>D</b>		
		 <b>350010</b> 1 module	1	 <b>35051..</b> 1 module	 <b>35054..</b> 4 modules	1	 <b>35021..</b> 1 module	1
		 <b>350020</b> 2 modules	1	 <b>35052..</b> 2 modules	 <b>352500</b> 6 modules	1	 <b>35022..</b> 2 modules	1
<b>ALLWHITE (WHITE)</b>  <b>2</b>		 <b>350030</b> 3 modules	1	 <b>35053..</b> 3 modules	 <b>35059..</b> 9 modules	1	 <b>35023..</b> 3 modules	1
		<b>Installation type</b>		<b>Surface-mounting boxes</b>		<b>Frames/plates</b>		
		<b>SURFACE-MOUNTING INSTALLATION</b>						
<b>ALLSTREET (GREY)</b>  <b>3</b>		 <b>35061..</b> 1 module		<b>B</b>		<b>D</b>		
		 <b>35062..</b> 2 modules		 <b>35064..</b> 4 modules	1	 <b>35021..</b> 1 module	1	
		 <b>35063..</b> 3 modules		 <b>35066..</b> 6 modules	1	 <b>35022..</b> 2 modules	1	
		 <b>35069..</b> 9 modules	1	 <b>35069..</b> 9 modules	1	 <b>35023..</b> 3 modules	1	

**CHOOSE YOUR FINISH:** Replace the dots in the Cat. No. with either 1, 2, or 3 to select the desired finish













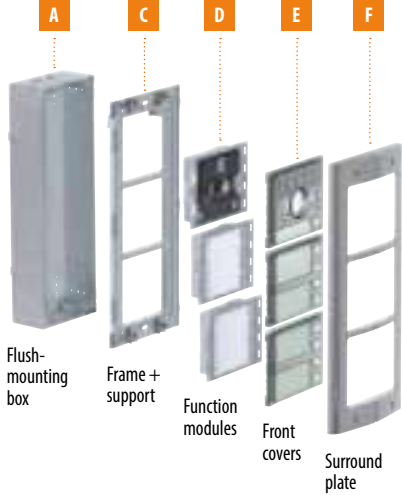









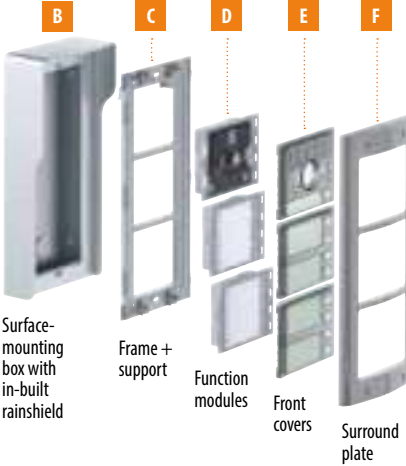

		Digital function modules		Front covers					
		Cat.Nos	Pack	Cat.Nos				Pack	
Speakers	<b>E</b>	<b>F Audio front covers</b>							
	 <b>351000</b> Basic speaker module (FOR AUDIO SYSTEMS ONLY)	1	 <b>35100..</b> Basic speaker module	 <b>35101..</b> Basic speaker module 1 push-button	 <b>35102..</b> Basic speaker module 2 push-buttons	 <b>35104..</b> Basic speaker module 2 push-buttons/double row	 <b>35108..</b> Basic speaker module 4 push-buttons/double row	1	
	 <b>351100</b> Speaker module	1	 <b>35110..</b> Speaker module	 <b>35111..</b> Speaker module 1 push-button	 <b>35112..</b> Speaker module 2 push-buttons	 <b>35114..</b> Speaker module 2 push-buttons/double row	 <b>35118..</b> Speaker module 4 push-buttons/double row	1	
Push-buttons	 <b>352000</b> 4 push-buttons/ single row	1	 <b>35203..</b> 3 push-buttons	 <b>35204..</b> 4 push-buttons	 <b>352011</b> 1 push-button	 <b>352021</b> 2 push-buttons		1	
	 <b>352100</b> 8 push-buttons/ double row	1	 <b>35216..</b> 6 push-buttons/double row	 <b>35218..</b> 8 push-buttons/double row	 <b>352121</b> 2 push-buttons/double row	 <b>352141</b> 4 push-buttons/double row		1	
Cameras	<b>E</b>	<b>F Video front covers</b>							
	 <b>351200</b> Audio/video	1	 <b>35120..</b> Audio/video	 <b>35121..</b> Audio/video 1 push-button	 <b>35122..</b> Audio/video 2 push-buttons/double row			1	
	 <b>351300</b> Audio/video with wide angle camera	1	 <b>35130..</b> Audio/video wide angle	 <b>35131..</b> Audio/video wide angle 1 push-button	 <b>35132..</b> Audio/video wide angle 2 push-buttons / double row			 <b>354000</b> Cable for the connection or several push-button modules L= 470 mm	1
 <b>352400</b> Night/day with wide angle camera	1	 <b>35240..</b> Night/day with wide angle camera						1	
Miscellaneous	<b>E</b>	<b>F Miscellaneous front covers</b>							
	 <b>352200</b> Name plate	1	 <b>35220..</b> Name plate						1
	 <b>352500</b> Graphic display	1	 <b>35250..</b> Graphic display						1
	 <b>352700</b> Inductive loop and control speech synthesis	1	 <b>35270..</b> Inductive loop-speech synthesis					 <b>35230..</b> Blanking reader	1
	 <b>353200</b> Badge reader	1	 <b>35320..</b> Badge reader						1
 <b>353000</b> Keypad	1	 <b>35300..</b> Numeric keypad	 <b>353011</b> Alphanumeric keypad					1	



# 2 WIRES SYSTEM



































## SFERA ROBUR

### Examples to select parts of the system

Finishes	Installation type	Flush-mounting boxes		Support frames		Frames/plates		
		Cat.Nos	Pack	Cat.Nos	Pack	Cat.Nos	Pack	
<b>VANDAL-RESISTANT (ROBUR)</b> 	<b>FLUSH-MOUNTING INSTALLATION</b> 	<b>A</b>  <b>350110</b> 1 module	1	<b>C</b>  <b>350315</b> 1 module	1	<b>D</b>  <b>350415</b> 1 module	1	
	 <b>350120</b> 2 modules	1	 <b>350325</b> 2 modules	1	 <b>350425</b> 2 modules	1		
	 <b>350130</b> 3 modules	1	 <b>350335</b> 3 modules	1	 <b>350435</b> 3 modules	1		
	<b>Installation type</b>	<b>Surface-mounting boxes</b>	<b>Support frames</b>	<b>Frames/plates</b>				
	<b>SURFACE-MOUNTING INSTALLATION</b> 	<b>B (*)</b>  <b>35061..</b> 1 module	 <b>35064..</b> 4 modules	1	<b>C</b>  <b>350315</b> 1 module	1	<b>D</b>  <b>350415</b> 1 module	1
	 <b>35062..</b> 2 modules	 <b>35066..</b> 6 modules	1	 <b>350325</b> 2 modules	1	 <b>350425</b> 2 modules	1	
	 <b>35063..</b> 3 modules	 <b>35069..</b> 9 modules	1	 <b>350335</b> 3 modules	1	 <b>350435</b> 3 modules	1	

(\*) CHOOSE YOUR FINISH: Replace the dots in the Cat. No. with either 1, 2, or 3 to select the desired finish - Refer to SFERA NEW finishes.



	Digital function modules		Front covers					
	Cat.Nos	Pack	Cat.Nos					Pack
Speakers	<b>E</b>  <b>351000</b> Basic speaker module (FOR AUDIO SYSTEMS ONLY)	1	<b>F</b> <b>Audio front covers</b>					
	 <b>351100</b> Speaker module	1	 <b>351005</b> Basic speaker module	 <b>351015</b> Basic speaker module 1 push-button	 <b>351025</b> Basic speaker module 2 push-buttons	 <b>351045</b> Basic speaker module 2 push-buttons/double row	 <b>351085</b> Basic speaker module 4 push-buttons/double row	1
Push-buttons	 <b>352000</b> 4 push-buttons/ single row	1	 <b>352035</b> 3 push-buttons	 <b>352045</b> 4 push-buttons				1
	 <b>352100</b> 8 push-buttons/ double row	1	 <b>352165</b> 6 push-buttons/double row	 <b>352185</b> 8 push-buttons/double row				1
Cameras	<b>E</b>  <b>351200</b> Audio/video	1	<b>F</b> <b>Video front covers</b>					
	 <b>351300</b> Audio/video with wide angle camera	1	 <b>351205</b> Audio/video	 <b>351215</b> Audio/video 1 push-button	 <b>351225</b> Audio/video 2 push-buttons / double row			1
	 <b>352400</b> Night/day with wide angle camera	1	 <b>351305</b> Audio/video wide angle	 <b>351315</b> Audio/video wide angle 1 push-button	 <b>351325</b> Audio/video wide angle 2 push-buttons / double row	 <b>354000</b> Cable for the connection or several push-button modules L= 470 mm		1
Miscellaneous	<b>E</b>		<b>F</b> <b>Miscellaneous front covers</b>					
	 <b>352200</b> Name plate	1	 <b>352205</b> Name plate					1
	 <b>352500</b> Graphic display	1	 <b>352505</b> Graphic display					1
	 <b>352700</b> Inductive loop and control speech synthesis	1	 <b>352705</b> Inductive loop-speech synthesis					1
	 <b>353200</b> Badge reader	1	 <b>353205</b> Badge reader	 <b>352305</b> Blanking reader				1
 <b>353000</b> Keypad	1	 <b>353005</b> Keypad					1	

## 2 WIRES SYSTEM

### SFERA

#### Electronic modules



351000



351100



351200



351300



352000



352100



352200

Item	Electronic modules
351000	<p><b>Basic speaker module</b> for the creation of 2 WIRE audio systems. Fitted with loudspeaker and microphone volume adjustment. It manages up to 100 pushbutton calls using additional double row pushbuttons. It can be used for opening an electrical door lock directly connected to the S+ and S- clamps (18 V 4 A impulsive - 250 mA holding current 30 Ohm max) and the connection to a local door lock release pushbutton on the PL clamps. To be completed with surround plate. The device must be physically configured.</p>
351100	<p><b>Speaker module</b> for the creation of 2 WIRE audio &amp; video systems. Fitted with loudspeaker and microphone volume adjustment. It can manage up to 100 pushbutton calls when using additional double row pushbutton modules. It can be used for opening an electrical door lock directly connected to the S+ and S- clamps (18 V 4 A impulsive - 250 mA holding current 30 Ohm max) and the connection to a local door lock release pushbutton on the PL clamps. Preset for additional power supply. Fitted with front LEDs for the notification of the operating status: door lock release, communication active, call put through, and system busy. Integrated optic sensor for the switching on of the night backlighting. To be completed with surround plate. The device can be configured either physically or using the PC and the TiSferaDesign software.</p>
351200	<p><b>Audio video module</b> for the installation of 2 WIRE colour video systems. With Colour camera with 1/3" sensor and white LEDs for the lighting of the shooting field. Mist prevention heating resistance. Loudspeaker and Microphone volume adjustments. It can manage up to 98 pushbutton calls using the additional double row pushbutton modules. Horizontal and vertical camera position adjustment, +/- 10° in both directions. It offers the possibility of opening an electrical door lock directly connected to clamps S+ and S- (18 V 4 A impulsive - 250 mA holding current 30 Ohm max) and of connecting a local door lock release pushbutton on clamps PL. Preset for additional power supply. Fitted with front LEDs for the notification of the operating status: door lock release, communication active, call put through, and system busy. Integrated optic sensor for the switching on of the night backlighting. To be completed with surround plate. The device must be configured physically or using a PC and the TiSferaDesign software.</p>

Item	Electronic modules
351300	<p><b>Wide angle audio/video module</b> for the installation of 2 WIRE colour video systems. With Colour camera with 1/3" sensor and white LEDs for the lighting of the shooting field. Mist prevention heating resistance. Loudspeaker and Microphone volume adjustments. It can manage up to 98 pushbutton calls using the additional double row pushbutton modules. It offers the possibility of opening an electrical door lock directly connected to clamps S+ and S- (18 V 4 A impulsive - 250 mA holding current 30 Ohm max) and of connecting a local door lock release pushbutton on clamps PL. Preset for additional power supply. Fitted with front LEDs for the notification of the operating status: door lock release, communication active, call put through, and system busy. Integrated optic sensor for the switching on of the night backlighting. To be completed with surround plate. The device must be configured physically or using a PC and the TiSferaDesign software</p>
352000	<p><b>Additional 4-pushbutton modules arranged on single column.</b> To be used with speaker modules 351000 - 351100 and audio/video modules 351200 - 351300. Connection using the appropriate multicable supplied. Backlighting of nameplates controlled by the speaker module or the audio/video module connected. To be completed with surround plate</p>
352100	<p><b>Additional 8-pushbutton modules arranged on double column.</b> To be used with speaker modules 351000 - 351100 and audio/video modules 351200 - 351300. Connection using the appropriate multicable supplied. Backlighting of nameplates controlled by the speaker module or the audio/video module connected. To be completed with surround plate</p>
352200	<p><b>Nameplate module</b> normally used for displaying the house number or other notifications (e.g. Legend for calls using digital pushbutton panels, opening/closing times, etc.). Connection using the appropriate multicable supplied. Night backlighting controlled by the speaker module or the audio/video module connected. To be completed with surround plate</p>

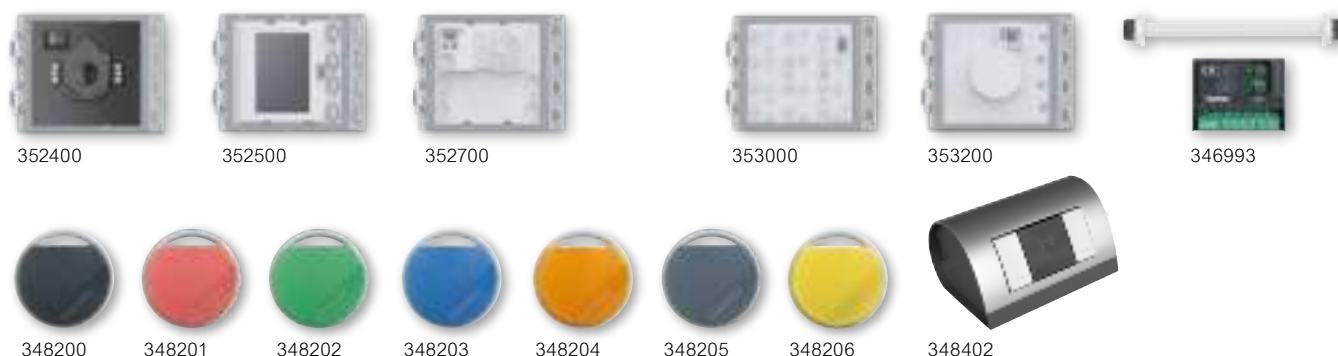

Item	Electronic modules
352400	<b>Night &amp; Day and wide angle camera module</b> for the installation of colour video systems. Fitted with 1/3" sensor with N&D function and automatic removal of the IR filter. IR LED for the lighting of the field of view. Mist prevention heating resistance. Automatic brightness adjustment. Connection to the speaker module (351100) using the multicable supplied. To be completed with surround plate
352500	<b>Graphic display module</b> to be used with speaker module 351100 or with audio/video modules 351200 - 351300 (connection using the multicable supplied). It can operate in two modes: call from address book, or digital call. The call from the address book gives the possibility of sending the call by scrolling on the display the names associated to the residents. It is possible to store up to 4000 residents names. Using the keypad module item 353000 it is also possible to directly call the apartment by entering the number corresponding to the resident. The digital call is also performed using the keypad module item 353000 by entering the numerical code. It is recommended that one or more nameplate modules, item 352200, are installed at the side of the pushbutton panel to display the correspondence between the numerical codes and the names of the users. It is possible to program the names in the address book in two different ways: manual inclusion using the pushbuttons of the display module or inclusion using a PC with the TiSferaDesign software installed, by downloading the file to the display module (RECOMMENDED). System power supply cuts do NOT cause the loss of memory data. To be completed with surround plate
352700	<b>Inductive loop and control speech synthesis module</b> to be used with the 351100 speaker module or with audio/video modules 351200 - 351300. Enable use by people wearing hearing aids (fitted with T selector) or blind people thanks to the connection status voice message synthesis (call active, call ended, no answer, busy, door open). It is connected to the speaker module using the appropriate multicable supplied. To be completed with surround plate. The device can be configured either physically or using the PC and the TiSferaDesign software

Item	Electronic modules
353000	<b>Keypad module</b> for door lock release, or for the digital call of the apartment (to be used with the display module). It is fitted with relay with contacts (C - NC - NO) and clamps (CP - P1 - P2) for the connection of a local door lock release pushbutton. The numerical code for the opening of the door lock can be programmed using the keypad itself, or using a PC after downloading the module programming file. It also has a programming reset pushbutton and LEDS for the visual notification of the access status. Night backlighting with LEDs. To be completed with surround plate. It is connected to the other modules using the appropriate multicable supplied. The device may also be used as a stand alone unit with independent power supply and operation per la sola apertura serratura. Configuration performed using physical configurators, or a PC with the TiSferaDesign software installed
353200	<b>RFID badge reader module</b> for the release of the door lock by swiping the badge. It manages up to 20000 badges. It's fitted with relay contacts (C - NO - NC) and clamps (CP - P1 - P2) for the connection of a local door release pushbutton. The badge for the release of the door lock can be programmed from the module itself, or using a PC after downloading the module programming file. It also has a programming reset pushbutton and LEDS for the visual notification of the access status. Night backlighting a LEDs. To be completed with surround plate. It is connected to the other modules using the appropriate multicable supplied. The device may also be used as a stand alone unit with independent power supply and operation. Configuration performed using physical configurators, or a PC with the TiSferaDesign software installed
346993	<b>Expander pushbutton module</b> that gives the possibility of connecting call pushbuttons to the SFERA speaker modules (items 351000; 351100; 351200; 351300). Each module can manage up to 8 call pushbuttons. It is possible to connect several expander pushbutton modules (max 96 call pushbuttons for each Entrance Panel)

Transponder keys and programmer	
348200	Black transponder key
348201	Red transponder key
348202	Green transponder key
348203	Blue transponder key
348204	Orange transponder key
348205	Grey transponder key
348206	Yellow transponder key
348402	Table-top transponder key programmer



# LINEA 3000

One entrance panel for every need

LINEA 3000 can be configured both for 1 and 2 family house



**ONE**  
FAMILY HOUSE

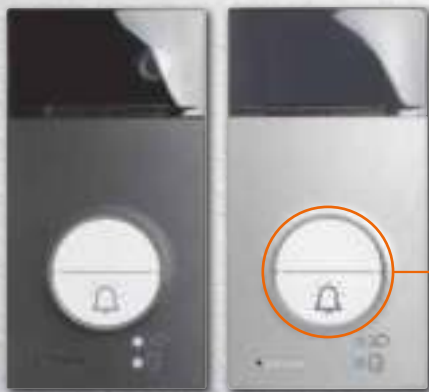

- Write the name on the one family nameplate label (supplied with the product).
- Set the internal micro-switch on position 1.

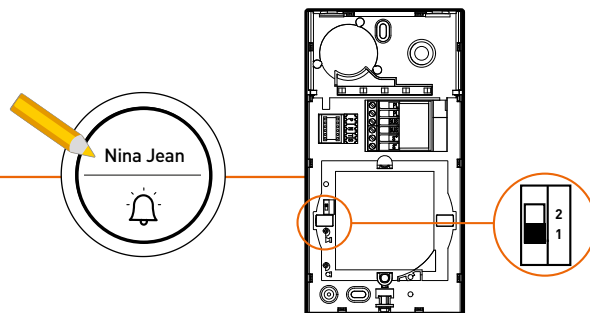

**TWO**  
FAMILY HOUSE

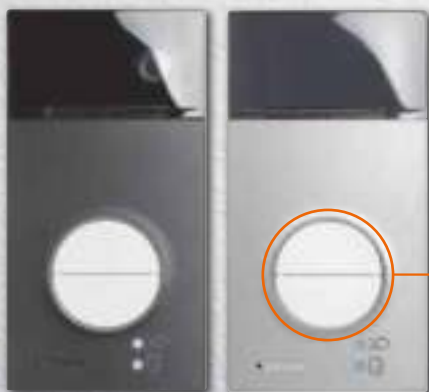

- Replace the nameplate label with the two family one (supplied with the product).
- Write the names on the two family nameplate label
- Set the internal micro-switch on position 2.

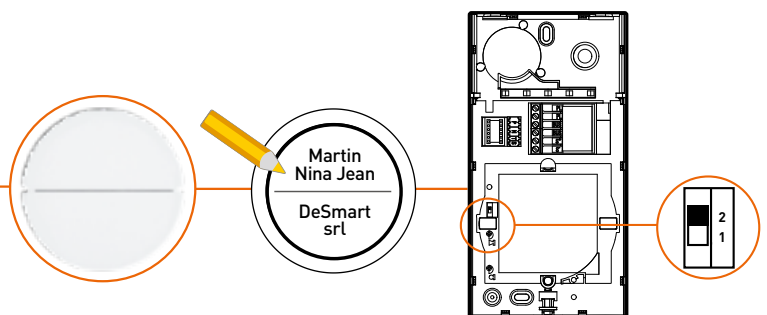





## LINEA 3000 inside of the new professional kits

For **ONE FAMILY** house installation, you have to buy only the kit and all you need is inside it.

For **TWO FAMILY** house installation, you have to buy the kit + an additional 2 wires internal unit. (refer to 2 wires system internal units range).

## High installation flexibility

- **LINEA 3000** is sold for wall mounting installation but with the dedicated **accessories** (to be purchased separately), you can use the entrance panel for **flush mounting installation**.

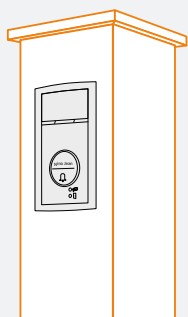

Also available in black version.

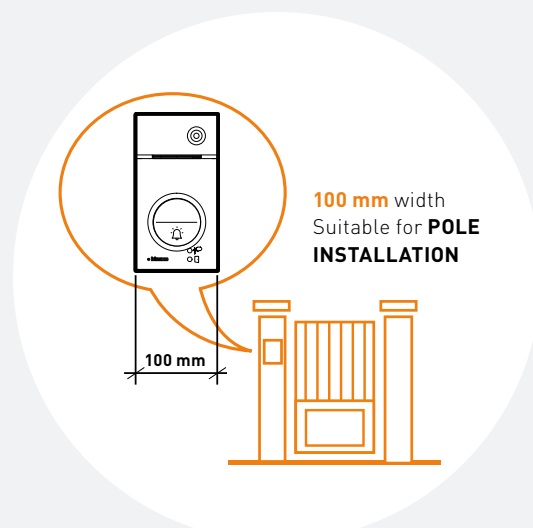

Ideal for renovations.....you can reuse the existing flush mounted box.  
Same 2 Modules Tersystem and SFERA flush mounting box.

- **LINEA 3000** can be wall mounted with the dedicated **(343051) rainshield accessory** (to be purchased separately).

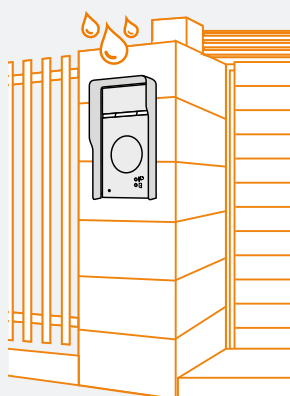

Also available in black version.

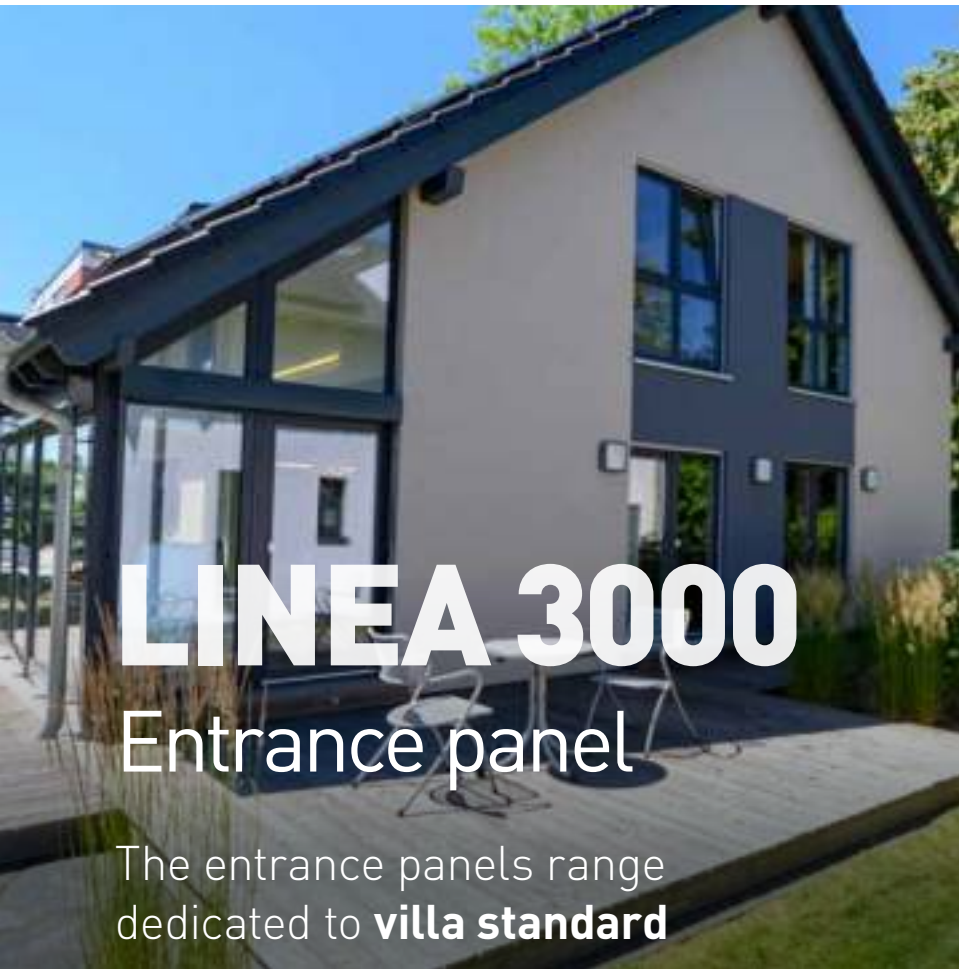

# LINEA 3000

## Entrance panel

The entrance panels range dedicated to **villa standard**

### Unique design and robust perception

Same look and ergonomics for all available versions:

**LINEA 3000** video with door lock release badge



343093



343091



**LINEA 3000** video



343081

**LINEA 3000** audio



343071



## HIGH LEVEL APPLICATIONS

Modern aesthetics feeling of quality



**refined detailing**



**branded quality**



**floating effect**



**hidden technology**



**high relevance on interaction**

**robustness**  
Zamak finishes



Weatherproof  
**(IP 54)**  
protection degree



Robustness  
**(IK 10)**  
protection degree

## Advanced functions

### WIDE ANGLE CAMERA

Horizontal and vertical wide viewing field. Easy to use for children and differently-abled People.



### DOOR LOCK RELEASE

Door lock release with coloured badges or clear discs. Additional safe and comfort for all the residents.



# 2 WIRES SYSTEM

## ENTRANCE PANEL

### LINEA 3000



343091

343093

343081

343071



348260



348261

Item	LINEA 3000 Video entrance panel with door lock release proximity reader
343091	Wall mounted 2-Wires video pushbutton panel with Zamak front cover, wide angle colour camera and proximity reader. Fitted with white LED for the lighting of the shooting field in low light conditions. Can be set up for one or two family installation. It provides the possibility of opening an electrical door lock connected directly to clamps S+ and S- (18 V 4 A impulsive, 250 mA holding current, 30 ohm max). Can manage a maximum of 20 badges (125 KHz) for electrical door opening (master system badge included). White LED backlight name plate. Protection degree IP54 – protection against mechanical impact IK10. Supplied 1 set of door opening badges made up of : 6 coloured badges and 2 clear discs.
343093	Same as 343091 but in black finish

Item	LINEA 3000 Video entrance panel
343081	Wall mounted 2-Wires video pushbutton panel with Zamak front cover and wide angle colour camera.. Fitted with white LED for the lighting of the shooting field in low light conditions. Can be set up for one or two family installation. It provides the possibility of opening an electrical door lock connected directly to clamps S+ and S- (18 V 4 A impulsive, 250 mA holding current, 30 ohm max). White LED backlight name plate. Protection degree IP54 – protection against mechanical impact IK10.

Item	LINEA 3000 Audio entrance panel
343071	Wall mounted 2-Wires pushbutton panel with Zamak front cover. Can be set up for one or two family installation. It provides the possibility of opening an electrical door lock connected directly to clamps S+ and S- (18 V 4 A impulsive, 250 mA holding current, 30 ohm max). White LED backlight name plate. Protection degree IP54 – protection against mechanical impact IK10.

Item	LINEA 3000 Spare part front covers
343082	Spare part front cover for video entrance panels 343081 and 343091.
343072	Spare part front cover for audio entrance panel 343071.
Door lock release badge and clear disc	
348260	Set made up of 6 coloured badges which can be programmed to open the door
348261	Set made up of 2 programmable clear discs which can be programmed to open the door





Item	LINEA 3000 Rainshield accessory
343051	Rainshield roof accessory for Linea 3000 (343071 – 343081 – 343091) entrance panels. To be purchased separately.
343053	Rainshield roof accessory for Linea 3000 (343093) entrance panel. To be purchased separately.

Item	LINEA 3000 Flush mounting accessory + plastic box
343061	Flush mounting frame accessory for Linea 3000 (343071 – 343081 – 343091) entrance panels. To be purchased separately.
343063	Flush mounting frame accessory for Linea 3000 (343093) entrance panel. To be purchased separately.
350020	Plastic box suitable for the flush mounting installation of Linea 3000 entrance panels (343071 - 343081 - 343091 - 343093) together with the specific frame accessory 343061 - 343063. To be purchased separately.





2 WIRES SYSTEM  
 ENTRANCE PANEL  
 LINEA 2000



Item	Wall mounted colour video entrance panel
343031	2 WIRE video pushbutton panel with a call key and colour camera. Fitted with white LEDs for the lighting of the shooting field in low light conditions. Aluminium front cover. Nameplate lit by green LED
343032	As item 343031, but with 2 call pushbuttons

Item	Wall mounted audio entrance panel
342911	2 WIRE audio pushbutton panel with one call pushbutton for wall mounted installation. Aluminium front cover. Nameplate lit by green LED
342921	As item 342911, but with 2 call pushbuttons
342931	As item 342911, but with 3 call pushbuttons
342941	As item 342911, but with 4 call pushbuttons



LINEA 100



343101



343102



343100

Item	Pushbuttons audio entrance panel
343101	2 WIRE audio pushbutton panel with 4 call pushbuttons for wall mounted installation. It's fitted with rainshield and internal contact (C - NO - NC) for the connection of an electrical door lock or external actuator (for the power supply to the electrical door lock allow for the installation of auxiliary transformer item 336482). Connections (PL) for a local door lock release pushbutton
343102	2 WIRE audio pushbutton panel with 8 call pushbuttons for wall mounted installation. It's fitted with rainshield and internal contact (C - NO - NC) for the connection of an electrical door lock or external actuator (for the power supply to the electrical door lock allow for the installation of auxiliary transformer item 336482). Connections (PL) for a local door lock release pushbutton

Item	Digital call audio entrance panel
343100	2 WIRE AUDIO digital call pushbutton panel for wall mounted installation. The device consists of a pushbutton panel with 16 keys and a digital display showing the operating status. Using previously saved numerical (SCS addresses) or alphanumeric (logical addresses) codes, it is possible to call the internal units, and for the residents to release the door lock using a dedicated numerical code. The pushbutton panel manages up to 4000 internal unit addresses (from 0 to 3999), as well as the direct call to the 2 WIRE switchboard. It's fitted with rainshield and internal contact (C - NO - NC) for the connection of an electrical door lock or external actuator (for the power supply to the electrical door lock allow for the installation of auxiliary transformer item 336482). Connections (PL) for a local door lock release pushbutton



# 2 WIRES SYSTEM ENTRANCE PANEL LINEA 300



308001  
308011

308002  
308012

308003  
308013

308004  
308014

308022

Item	Aluminium finish pushbutton panel
308001	Monobloc vandal-resistant 2 WIRE video pushbutton panel for 2 and 4 calls with aluminium finish. The item code includes: flush mounted box, frame, colour video and audio electronic module, prewired pushbutton module/s. Presetting for the mounting of transponder reader or key switch. Backlit call keys. Visual and sound notifications of the communication status for: call active, system busy, door lock status
308002	As item 308001 but for up to 8 calls
308003	As item 308001 but for up to 12 calls
308004	As item 308001 but for up to 20 calls
308005	As item 308001 but for up to 32 calls

Item	Stainless steel finish pushbutton panel
308011	Monobloc vandal-resistant 2 WIRE video pushbutton panel for 2 and 4 calls with stainless steel finish. The item code includes: flush mounted box, frame, colour video and audio electronic module, prewired pushbutton module/s. Presetting for the mounting of transponder reader or key switch. Backlit call keys. Visual and sound notifications of the communication status for: call active, system busy, door lock status
308012	As item 308011 but for up to 8 calls
308013	As item 308011 but for up to 12 calls
308014	As item 308011 but for up to 20 calls
308015	As item 308011 but for up to 32 calls

Wall mounted boxes	
308021	Wall mounted box for pushbutton panels, items 308001-308011
308022	Wall mounted box for pushbutton panels, items 308002-308012
308023	Wall mounted box for pushbutton panels, items 308003-308013
308024	Wall mounted box for pushbutton panels, items 308004-308014
308025	Wall mounted box for pushbutton panels, items 308005-308015



308040                      308026



**Digital call entrance panel with flush mounting box**

Item	Digital call entrance panel
308040	<p>Monobloc vandal-resistant 2 WIRE digital call video pushbutton panel (in stainless steel), flush mounted or wall mounted installation (with specific box item 308026 sold separately). The item includes: flush mounted vandal-resistant steel box, audio and video module with wide angle colour camera, integrated graphic display, and alphanumeric keypad for direct apartment call, fast address book search, and door lock release using a code. Presetting for the installation of a T25 Vigik reader, or a key switch. Backlit display and BLUE keys. It is possible to store up to 4000 residents names. Visual, sound, or control speech synthesis communication status notification, for example: call active, system busy, door lock status. Direct control of an electric door lock 18V-4A impulsive, 250 mA holding current (30 ohm max). System power supply cuts do NOT cause the loss of memory data. Selectable display menu languages are: Italian, English and French.</p> <p>The device can be configured physically or using a PC with the specific software, which can be downloaded free of charge from <a href="http://www.homesystems-legrandgroup.com">www.homesystems-legrandgroup.com</a></p>
308026	<p>Wall mounted box for digital call entrance panel 308040</p>

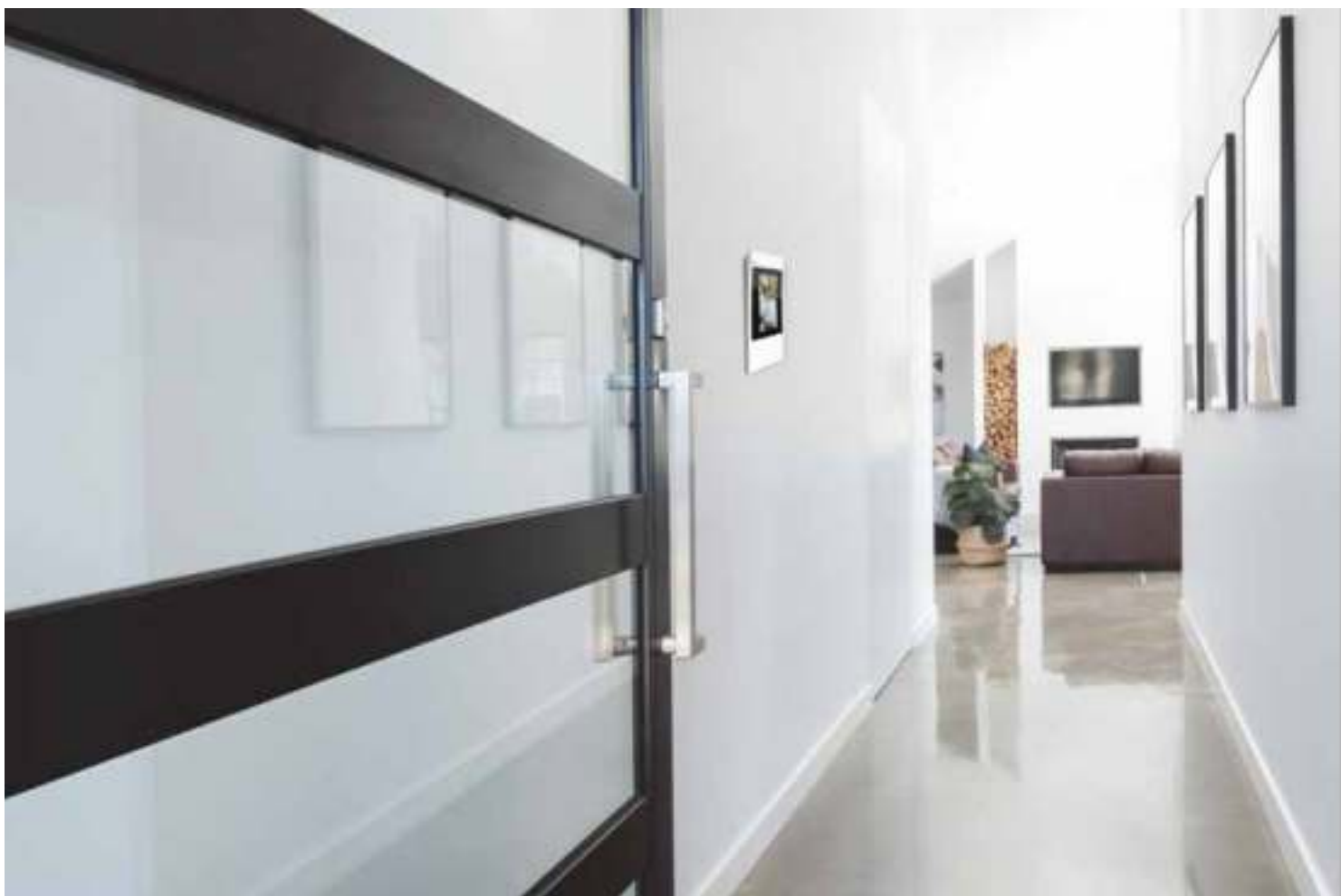

# INTERNAL UNITS RANGE

- > CLASSE 300EOS
- > CLASSE 100
- > SPRINT L2





alex | built-in

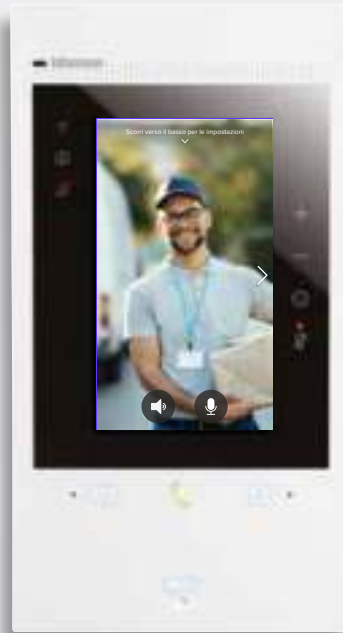

**CLASSE 300E0S**



**CLASSE 100 X16E**



**CLASSE 100 A16E**

# 2 WIRES SYSTEM

## INTERNAL UNITS

### Overview and features

	Classe 300EOS with Netatmo 	Classe 100X16E with Netatmo 	Classe 100V16E 
Audio			
Colour video	●	●	●
Handsfree	●	●	●
Call redirection on smartphone	●	●	
Integrated Alexa voice assistant	●		
Wifi connection	●	●	
Finishes / Colours	White - Black	White	White
Display	LCD Touch 5"	LCD 5"	LCD 5"
Answering machine	●		
Floor call	●	●	●
Door lock release	●	●	●
Staircase light control	●	●	●
Scrolling EP activation	●	●	●
Intercom (1)	●	●	●
Inductive loop (2)	●	●	●
Professional studio function	●	●	●
Safe door lock function	●	●	●
Note / message function	●		
Quick link / Favourite	●		
Wall-mounted installation	●	●	●
Tabletop installation		●	●

(1) The intercom function allows for up to 3-minute communication between and among video door entry systems in the same apartment / in different apartments.

(2) Use by people wearing hearing aids fitted with (T) selector.

(3) Activated with specific configuration inserted in P.



Classe 100V16B	Classe 100V16M	Classe 100A16E	Classe 100A16M	Sprint L2
		•	•	•
•	•			
•		•		
White	White	White	White	White
LCD 5"	LCD 4,3"			
•	•	•	•	•
•	•	•	•	•
•	•	•	•	• (3)
•	•	•	•	• (3)
•	•	•	•	
		•	•	
•	•	•	•	
	•			
•	•	•	•	•
•		•	•	

# CLASSE 300EOS

THE EVOLUTION OF SMART



Video door  
entry system



Management  
with smartphone



Voice  
control



Smart  
Home



Smart  
Security



Classe 300EOS with Netatmo is the 2 wires / Wi-Fi handsfree connected video internal unit with built-in Amazon Alexa voice assistant. Using the Home + Security App, in addition to video door entry calls, it is also possible to manage the devices of the Netatmo security range, creating a simple and fast Smart security system.

CLASSE  
300EOS | WITH Netatmo

Change your idea of a video internal unit.





2 WIRES SYSTEM  
INTERNAL UNITS  
CLASSE 300EOS with Netatmo



## The smart vision of the home.

Distinctive design to meet the needs of contemporary living. Vertical and super slim. With its clean and modern design, it gives every type of home an innovative look, and offers a unique user experience.



Vertical display and curved shape: a disruptive and modern design, but also understated.

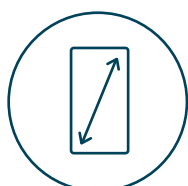

**5" Touch Screen**

Vertical display for a better view of the caller

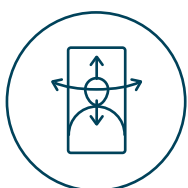

**Face detection**

Automatic centring of the subject on the display



**Horizontal display**

Double "tap" the display to view the image in landscape format

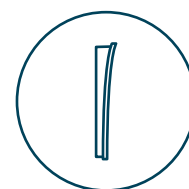

**Curved shape**

The shape of a welcome: a "welcoming effect" for residents and guests.



2 WIRES SYSTEM  
INTERNAL UNITS  
CLASSE 300EOS with Netatmo

# Always aware with the Home + Security App



**Home + Security**

The best App for a safe home

Alerts and notifications for incoming calls, motion and people detection, event information and door lock management with a simple and intuitive interface.





Answer the calls,  
activate the electrical door locks,  
activate the cameras and display  
the timeline of the events

-  
Manage up to 20 homes  
with your single account



Home + Security



**Incoming call**  
Receive notification  
when someone  
is calling

**See who's calling**  
Answer the call and  
open the gate for  
the courier

**Check the events**  
Check who called you  
and if they left you  
a message

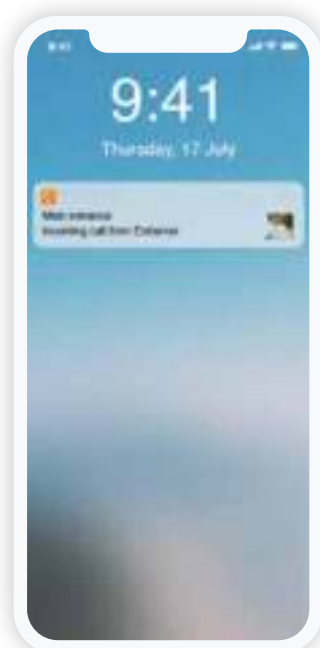

**Quick actions**  
- Activate the electrical door locks  
- Activate the timed staircase lights  
- Call home / Intercom  
- Activate the cameras  
- Manage the video door entry  
answering machine



2 WIRES SYSTEM  
INTERNAL UNITS  
CLASSE 300EOS with Netatmo

Security enhancement with integration of Netatmo devices

# Video door entry system and security. Together.

<p><b>Video door entry system</b> ...</p>  <p><b>Main entrance</b> Incoming entrance call.</p>	<p><b>Security</b> ...</p>  <p><b>Secondary entrance and interiors</b> Smart Outdoor Camera with Siren and movement detection. Smart Indoor Camera with face recognition.</p>
--	--



A single App with an intuitive home page. It allows you to answer video door entry calls, activate the door lock and view images from Netatmo smart outdoor and indoor cameras.





**Professional opportunity:** offer your services as an installer of simple smart security systems.  
**Business opportunities:** access to a catalogue of smart and easy-to-install security devices.

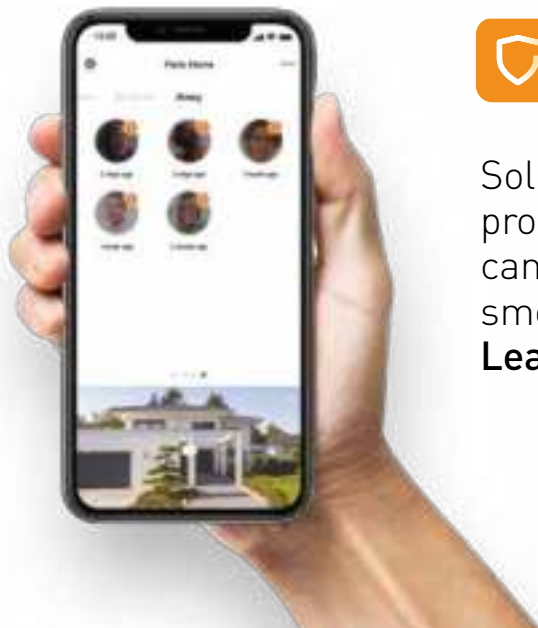

**Home + Security**  
**The best App for a safe home.**

Solutions for a smart and complete protection of your home: security cameras, alarms, opening sensors, smoke detector...

**Leave your home without worries.**

WITH  
**Netatmo**

**Examples of Netatmo solutions natively integrated in the Home + Security App**



Smart Outdoor Camera



Smart Outdoor Camera with Siren



Smart Indoor Camera



Smart Door and Window Sensors



Smart Video Doorbell



Smart Indoor Siren



Smart Smoke Alarm



Smart Carbon Monoxide Alarm

2 WIRES SYSTEM  
INTERNAL UNITS  
CLASSE 300EOS with Netatmo



## The first video internal unit with built-in Alexa

**Enjoy the full Alexa experience**  
interacting with all its functions, such as:  
Custom routines - Play Music - Smart Home  
To set the clock alarms - Memos and  
**video door entry functions.**



Add any compatible “works with Alexa” devices, to offer your customers an increasingly Smart home.



*“Alexa, open the gate”*



*“Alexa, answer the call”*



*“Alexa, I go out”*

**NOTE:** Alexa is not available in all languages and Countries.  
Alexa features and functionality may vary by location.

# 2 WIRES SYSTEM

## INTERNAL UNITS

### CLASSE 300EOS with Netatmo



## Back view

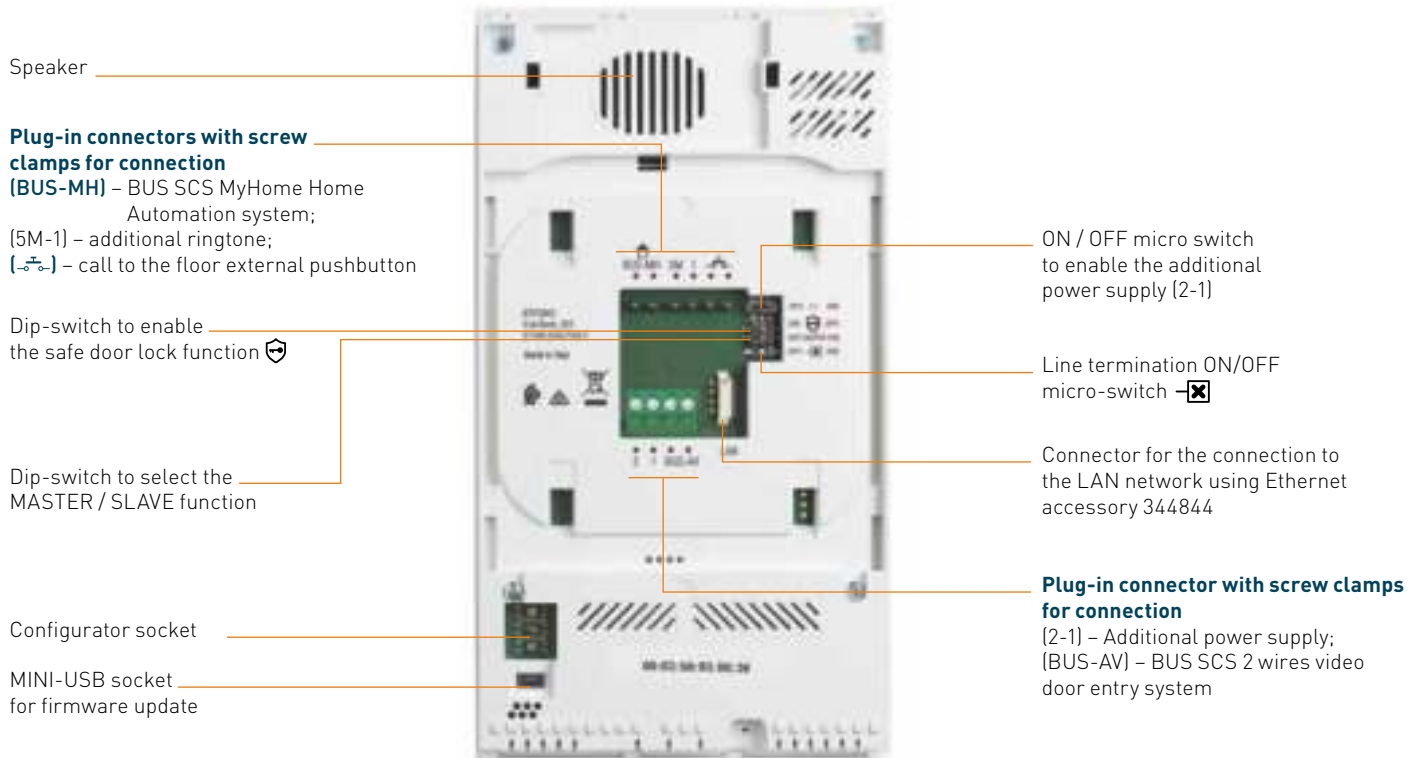



# INTERNAL UNITS

## CLASSE 300EOS with Netatmo



344842



344884



344844



346020

Item	CLASSE 300EOS WITH NETATMO connected video internal unit –white finish
344842	<p>2 wires/Wi-Fi handsfree connected video internal unit white finish with built-in Amazon Alexa voice assistant, 5" vertical touch screen LCD display and video door entry answering machine. Integrated SCS Server for managing MyHOME wired systems. It can be used alternatively to the SCS Server DIN Item MhServer 1. It has a physical key for door lock release and capacitive keys for the control of the main video door entry functions: handsfree communication, entrance panel activation / camera scrolling and Favourite key (can be configured to activate the quick actions most frequently used – e.g. additional door locks, staircase light control, intercom). There are notification LEDs for: Wi-Fi network connection status, info / notifications and call exclusion. It is possible to easily interact with the built-in Alexa voice assistant, either using the dedicated capacitive keys or with your voice, and activate several functions, such as the video door entry functions, Smart Home, scenarios, reminders etc. Using the touch display, it is possible to access the notification list, as well as your favourite door entry, security and Smart Home controls (if any). The device must be configured by physically connecting the configurators or using the menu, which will give better possibilities of customisation of associated functions and texts. Thanks to the Wi-Fi connection, you can associate the video internal unit to the Home + Security App (available for Android and iOS). The App allows to use the main video internal unit functions (receiving calls, door lock release, display of the event timeline and activation of the entrance panel/camera cycling). Through the Home + Security App, it is also possible to manage the products of the Netatmo security range (outdoor and indoor cameras, door and window sensors, indoor siren and smoke detector). This allows you to quickly and easily create a Smart security system. Wall mounted installation using the supplied bracket. Possibility of Wi-Fi connection or using RJ45 ethernet cable with the dedicated accessory 344844.</p>

Item	CLASSE 300EOS WITH NETATMO connected video internal unit – black finish
344884	Same as 344842 but in Black finish.
<b>Ethernet accessory</b>	
344844	Accessory cable for the wired connection of the Classe 300EOS video internal unit using an RJ45 Ethernet cable. To be purchased separately.
<b>2 DIN additional power supply</b>	
346020	Additional 2 DIN power supply to be used to supply the connected CLASSE 300EOS video internal units (344842 - 344884) locally, when required.





2 WIRES SYSTEM  
INTERNAL UNITS  
CLASSE 100



Classe 100 X16E  
with Netatmo

# Now the standard is connected

BTicino renews the range of Classe 100 indoor units by introducing Wi-Fi connectivity in the standard video door entry system offer. The result is a range of video and audio indoor units with a modern and elegant design, capable of meeting all installation needs.



**Built-in connectivity** for constant connection with the home.

22  
apt

Up to 22 apartments without dedicated power supply.

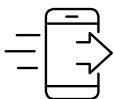

Immediate association with the Home + Security App.



Ideal for the refurbishment of old door entry systems.



No extra work for the installer; easier to use for the end user.



After being connected to Classe 100X, the smartphone becomes an “additional virtual video indoor unit” that can be used to answer calls, activate the opening of the door locks and activate the system cameras.

# Always aware with the Home + Security App



**Home + Security**

The best App for a safe home

Alerts and notifications for incoming calls, motion and people detection, event information and door lock management with a simple and intuitive interface.





Answer the calls,  
activate the electrical door locks,  
activate the cameras and display  
the timeline of the events

Manage up to 20 homes  
with your single account



Home + Security



**Incoming call**  
Receive notification  
when someone  
is calling

**See who's calling**  
Answer the call and  
open the gate for  
the courier

**Check the events**  
Check who called  
you thanks to the  
event timeline

**Quick actions**  
- Activate the electrical door locks  
- Activate the timed staircase lights  
- Call home / Intercom  
- Activate the cameras



2 WIRES SYSTEM  
INTERNAL UNITS  
CLASSE 300EOS with Netatmo

Security enhancement with integration of Netatmo devices

# Video door entry system and security. Together.

## Video door entry system



**Main entrance**  
Incoming entrance call.

## Security



**Secondary entrance and interiors**  
Smart Outdoor Camera with Siren and movement detection. Smart Indoor Camera with face recognition.



A single App with an intuitive home page. It allows you to answer video door entry calls, activate the door lock and view images from Netatmo smart outdoor and indoor cameras.





**Professional opportunity:** offer your services as an installer of simple smart security systems.  
**Business opportunities:** access to a catalogue of smart and easy-to-install security devices.

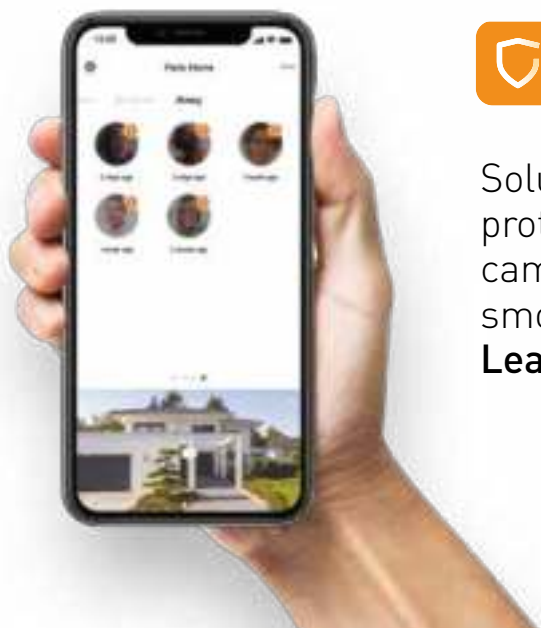

**Home + Security**  
**The best App for a safe home.**

Solutions for a smart and complete protection of your home: security cameras, alarms, opening sensors, smoke detector...

**Leave your home without worries.**

WITH  
**Netatmo**

**Examples of Netatmo solutions natively integrated in the Home + Security app**



Smart Outdoor Camera



Smart Outdoor Camera with Siren



Smart Indoor Camera



Smart Door and Window Sensors



Smart Video Doorbell



Smart Indoor Siren



Smart Smoke Alarm



Smart Carbon Monoxide Alarm

# 2 WIRES SYSTEM

## INTERNAL UNITS

### CLASSE 100

## Features and functions

Classe 100 X16E with Netatmo	Classe 100 V16E	Classe 100 V16B	Classe 100 V16M	Classe 100 A16E	Classe 100 A16M
					
344682	344672	344652	344625	344282	344292

FEATURES						
LCD colour display	5 inches	5 inches	5 inches	4.3 inches		
Handsfree	●	●	●		●	
Finish	white	white	white	white	white	white
Available in KIT	364614	364612	364613		364232	364231
Installation	wall / table	wall / table	wall / table	wall	wall / table	wall / table

AVAILABLE FUNCTIONS FROM AUDIO / VIDEO INDOOR UNIT						
Door lock activation	●	●	●	●	●	●
Staircase light activation	●	●	●	●	●	●
EP / Scrolling activation	●	●	●	●	●	●
Intercom (1)	●	●	●	●	●	●
Inductive loop (2)	●	●				
Floor call	●	●	●	●	●	●
No. of configurable keys	4	4	1	1	4	4
No. of available ringtones	20	16	16	16	16	16
Professional Studio (Office)	●	●			●	●
Wi-Fi connectivity	●					





AVAILABLE FUNCTIONS FROM HOME + SECURITY APP						
Answer video door entry system calls	●					
Door lock activation	●					
Staircase light activation	●					
Intercom call from smartphone to video indoor unit	●					
Management Netatmo Security devices (smoke sensor , burglar alarm siren , opening sensor	●					
EP / Scrolling activation	●					

1) Audio call, max. 3 minutes, between indoor units of the same apartment/different apartments  
 2) Use by people wearing hearing aids fitted with T selector





## Front view

### Touch sensitive controls

-  Door lock activation
-  Entrance panel/camera scrolling activation
-  Staircase light activation
-  Customisable controls for the activation of accessory functions (e.g. intercom, activation of additional door lock, various activations)



### LED notifications

-  Wi-Fi Connection
-  Ringtone exclusion

### Physical control

Enable the handsfree communication

Tactile guide

### Physical control

Disable the handsfree communication

## Rear view

Plug-in connectors with screw clamps for connections

Adjustment and programming menu access and navigation joystick

Line termination ON/OFF micro-switch

ON / OFF micro switch to enable the additional power supply

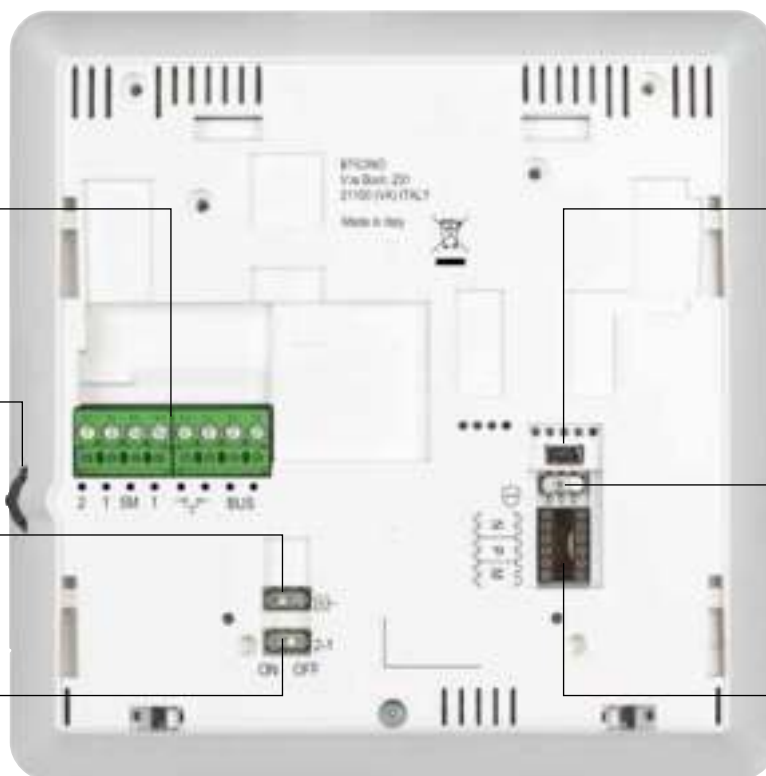

USB mini socket for firmware update

ON / OFF micro switch to enable the Safe Door Lock function

Configurator socket

# 2 WIRES SYSTEM

## INTERNAL UNITS

### CLASSE 100



344682



344672



344652



344625

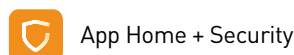

App Home + Security

Item	<b>CLASSE 100X16E connected video indoor unit</b>
344682	<p>Classe 100X16E with Netatmo 2 wires / Wifi handsfree connected video internal unit with inductive loop and 5" colour LCD display. It has 2 physical keys for the control of the main video door entry functions – answer and end a call – it has 3 touch keys for the control of the main functions – door lock release, staircase light control and entrance panel activation/scrolling – there are further 4 configurable touch keys that perform different functions – e.g. staircase light control, intercom, additional door lock activation, generic activations. The device has a side lever to adjust: colour, brightness and display contrast, audio volume, call tone volume and Wifi configuration. There are call exclusion notification LEDs and Wifi. Also, thanks to the Wifi connection, you can associate the video internal unit to the Home + Security App (available for Android and iOS). You can manage the main video internal unit functions (receiving calls, opening the door lock, activating the entrance panel/scrolling, FWR updating and additional activations) from the App. Through the Home + Security App it is also possible to manage the products of the Netatmo security offer (Outdoor and Indoor cameras, door and window sensors, internal siren and smoke detector). This allows you to quickly and easily create a Smart security system. The installation can be made to the wall using the bracket supplied or using table support accessories (2 x 344692) – to be purchased separately. The device, also equipped with the professional studio (office) function, must be configured.</p>

Item	<b>CLASSE 100V16B video indoor unit</b>
344652	<p>2 WIRES handsfree video indoor unit with 5" colour LCD display. The device has 2 physical keys for the control of the main video door entry functions – answer and end a call – and 3 touch keys that allow the door lock release, the entrance panel activation/scrolling and the customisation of a most frequently used quick action – e.g. staircase light control, intercom, additional door lock activation, generic activations. The device has a side lever to adjust: colour, brightness and display contrast, audio and call tone volume. There is a call exclusion notification LED. The installation can be made to the wall using the bracket (supplied) or using table support accessories (2 x 344692) – to be purchased separately. The device must be configured.</p>

Item	<b>CLASSE 100V16E video indoor unit</b>
344672	<p>2 WIRES handsfree video indoor unit, with inductive loop and 5" colour LCD display. It has 2 physical keys for the control of the main video door entry functions – answer and end a call – it has 3 touch keys for the control of the main functions – door lock release, staircase light control and entrance panel activation/scrolling – there are further 4 configurable touch keys that perform different functions – e.g. intercom, additional door lock activation, generic activations. The video indoor unit has a side lever to adjust: colour, brightness and display contrast, audio and call tone volume. There is a call exclusion notification LED. The installation can be made to the wall using the bracket (supplied) or using table support accessories (2 x 344692) – to be purchased separately. The device also has Professional Studio (Office) function and must be configured.</p>

Item	<b>CLASSE 100V16M video indoor unit</b>
344625	<p>2 WIRES video indoor unit with handset and 4.3" colour LCD display, suitable for wall mounting installation (bracket support included). The device has three touch keys that allow: door lock release, entrance panel camera activation/scrolling and customization of an auxiliary function – e.g. additional door lock activation, additional camera activation. Side easily accessible and independent regulations for: call volume / ringtone exclusion (with notification LED), display colour and brightness. The handset has magnets for easy holding.</p>



344282



344292



344692



336803



336982



346020

Item	<b>CLASSE 100A16E handsfree audio indoor unit</b>
344282	<p>2 WIRES handsfree audio indoor unit for wall mounted or table installation.</p> <p>It has 2 physical keys for the control of the main functions – answer and end a call – and has 3 touch keys for the control of the main functions – door lock release, staircase light control and entrance panel activation/scrolling – there are further 4 configurable touch keys that perform different functions – e.g. intercom, additional door lock activation, generic activations. The device has a side lever to adjust the audio volume and call tone and a call exclusion notification LED.</p> <p>The installation can be made to the wall using the bracket (supplied) or using table support accessory (1 x 344692) – to be purchased separately. The device also has Professional Studio (Office) function and must be configured.</p>

Item	<b>CLASSE 100A16M audio indoor unit with handset</b>
344292	<p>2 WIRES audio indoor unit with handset for wall mounted or table installation. It has 3 touch keys for the control of the main functions – door lock release, staircase light control and entrance panel activation/scrolling – there are further 4 configurable touch keys that perform different functions – e.g. intercom, additional door lock activation, generic activations. Ringtone volume adjustment (with call exclusion) using the appropriate selector. The installation can be made to the wall using the bracket (supplied) or using table support accessory (1 x 344692) – to be purchased separately. The device also has Professional Studio (Office) function and must be configured.</p>

Item	<b>Accessories - table support - cable - sockets</b>
344692	Table support accessory for CLASSE 100 audio and video hands-free indoor units.
336803	8-way cable with connector for tabletop support connection.
336982	<p>White Livinglight series 8-pole plug for the connection of the 336803 cable in tabletop installations.</p> <p>The socket is available also in the following finishings:                      - LIVINGLIGHT (336983 - 336984);                      - AXOLUTE (349414 - 349415 - 349418);                      - MATIX (336985).</p>

Item	<b>2 DIN additional power supply</b>
346020	Additional 2 DIN power supply to be used for the local power supply to connected CLASSE 100x16E (344682) video indoor units in multi-family systems in complexes with more than 22 apartments.



# 2 WIRES SYSTEM

## INTERNAL UNITS

### Netatmo safety devices

#### Home + Security App



Item	Smart outdoor camera
NOC-PRO	Smart outdoor safety camera with detection of people, animals and vehicles. Aluminium single monobloc construction. Ultra-resistant glass and plastic, protection against UV rays. Video sensor: 4MP. Resolution: Full HD 1080 p. Coding: H.264. Long-range detection: up to 20 m. Field of view: 100°. 8x digital zoom for videos. Video live microphone. LED spotlight: 12 W, variable intensity. Infrared night vision: 15 m. Encryption protected access to the smartphone using the Home + Security App. Weather resistant: designed for outdoor use (HZO protection).

Item	Smart indoor camera
NSC-PRO	Smart indoor safety camera with people detection consisting of an aluminium monobloc unit. Video sensor: 4MP. 130° panoramic view for a wider coverage. High quality video with Full HD 1080 p viewing. Guaranteed day and night protection with infrared vision, for comfortable viewing even in total darkness. Recording only in case of intrusion, in respect of the privacy of the family. Encryption protected access to the smartphone using the Home + Security App. Declaration of conformity and FCC declarations. Open-source compatibility. It has to be connected to an electric socket with the supplied AC adapter.

	Smart outdoor camera with siren
NOC-S-PRO	Smart outdoor safety camera with detection of people, animals and vehicles. Equipped with 105 db alarm siren. Aluminium single monobloc construction. Ultra-resistant glass and plastic, protection against UV rays. Video sensor: 4MP. Resolution: Full HD 1080 p. Coding: H.264. Long-range detection: up to 20 m. Field of view: 100°. 8x digital zoom for videos. Video live microphone. LED spotlight: 12 W, variable intensity. Infrared night vision: 15 m. Encryption protected access to the smartphone using the Home + Security App. Weather resistant: designed for outdoor use (HZO protection).
NOC-S-W-PRO	Features like NOC-S-PRO. White finish.

	Smart video alarm system
NBU-AS-PRO	Smart video security alarm system consisting of 1 smart indoor camera, 1 smart indoor siren and 3 smart door and window opening sensors. The products can be easily configured and associated using the Home + Security app. The smart video alarm system activates and deactivates automatically, has pre-recorded sounds to simulate a presence in the home, respects the privacy of the family and activates a 110 dB sound in case of intrusion.

	Smart door and window sensors
DTG-PRO	Smart opening sensors for doors and windows ideal for safety. Sensors with waterproof monobloc construction, vibration/motion detection and open/closed status. Power supply with 2 AAA-type batteries included in the package. They only work with the smart indoor camera (sold separately): radio link between the sensors and the camera. Declaration of conformity and FCC. Open-source compatibility. Can be controlled and managed remotely with Home + Security app.



NDB - PRO



NSA - PRO - EU



NIS - 01 - PRO



NCO - PRO

Item	Smart video doorbell
NDB-PRO	Smart video doorbell for outdoor installation. Allows you to receive a video call on your smartphone when someone rings the doorbell. Equipped with Camera: 2 megapixels, 5x digital zoom. HDR function of automatic adaptation to lighting conditions. Infrared night vision even in conditions of total absence of brightness. Video: Full HD 1080 p, portrait format 9:16. Field of view: 140° diagonal. Sound: high-quality speaker and microphone. Night vision: Infrared LED. Operating temperature: -10° to 40° C. Weather resistant: HZO protection and IP44 certification. Power supply: 8-24 VAC & 230 VAC; minimum 8 VA. Local storage on microSD memory card and optional storage on Dropbox or FTP server MicroSD card up to 32 GB (class 10). Data protection with encrypted connection for the highest level of privacy. Requirements: high speed internet access. The minimum required upload and download speed is 25 KB/s. Hotspots are not supported. Wireless specifications: Wi-Fi 802.11 b/g/n (2.4 GHz), Open/WEP/WPA/WPA2-personal. Operation via Home + Security app (iOS 10 required minimum - Android 5.0 required minimum). Compatible with Apple HomeKit, Google Assistant and Amazon Alexa. <a href="http://www">www</a>

Item	Smart smoke alarm
NSA-PRO-EU	Smart Smoke Alarm with 85 dB alarm, high performance photoelectric sensor, average coverage 50 m². When it detects the presence of smoke, it activates its 85-decibel alarm and immediately alerts you to your smartphone. It is equipped with a 10-year battery - the maximum lifetime for all smoke detectors. The Self-Test feature checks if the Smart Smoke Alarm is functioning correctly. If it detects a problem, it sends a notification to your smartphone. Reliability guaranteed by CE (EN 14604) and NF certifications. Standalone device, no hub required. Compatible with Apple HomeKit. Operation via the Home + Security app. Requirements: High-speed wireless internet connection needed. Public hotspots not supported. The Smart Smoke Alarm will detect smoke and will sound even if the Wi-Fi isn't configured. However, you will need Wi-Fi to receive smartphone alerts. Wi-Fi 802.11 b/g/n (2.4 GHz), Open/WEP/WPA/WPA2-Personal, Bluetooth Low Energy (BLE).

Item	Smart indoor siren
NIS-01-PRO	Smart indoor siren with 110 dB alarm, pre-recorded sounds and vibration sensor for tamper detection. Battery power supply or with a cable (not supplied) using the USB micro port. It only works with the smart indoor camera and must be installed in the same room: Bluetooth Low Energy (BLE) wireless connection with the smart indoor camera. Declaration of conformity and FCC declarations. Open-source compatibility. Operation using the Home + Security app.

Item	Smart carbon monoxide alarm
NCO-PRO	Smart carbon monoxide alarm / detector for wall installation. It allows to monitor the fuel-burning appliances (boiler, fireplace, wood-burning stove, gas cooker, etc.) by measuring, in real time, the levels of carbon monoxide, which is an invisible, odourless and potentially fatal gas. When it detects the presence of carbon monoxide, it activates its 85-decibel alarm and immediately alerts you to your smartphone. It is equipped with a 10-year battery - the maximum lifetime for all carbon monoxide detectors. The Self-Test feature checks if the Smart Carbon Monoxide Alarm is functioning correctly. If it detects a problem, it sends a notification to your smartphone. Reliability guaranteed by CE (EN 50291) and NF certifications. Standalone device, no hub required. Compatible with Apple HomeKit. Operation via the Home + Security app. Requirements: High-speed wireless internet connection needed. Public hotspots not supported. The Smart Carbon Monoxide Alarm will detect Carbon Monoxide and will sound even if the Wi-Fi isn't configured. However, you will need Wi-Fi to receive smartphone alerts. Wi-Fi 802.11 b/g/n (2.4 GHz), Open/WEP/WPA/WPA2-Personal, Bluetooth Low Energy (BLE).

## 2 WIRES SYSTEM INTERNAL UNITS SPRINT L2



344242



344232

Item	SPRINT L2 audio handsets
344242	2 WIRE audio handset (without the possibility of fitting with accessories) for audio systems and mixed audio /video systems. Wall mounted installation without the need of accessories. With door lock release key and auxiliary functions key (that can be configured). Ringtone volume adjustable on 3 levels. White
344232	As item 344242 but with call to the floor function

### DIMENSIONAL DATA

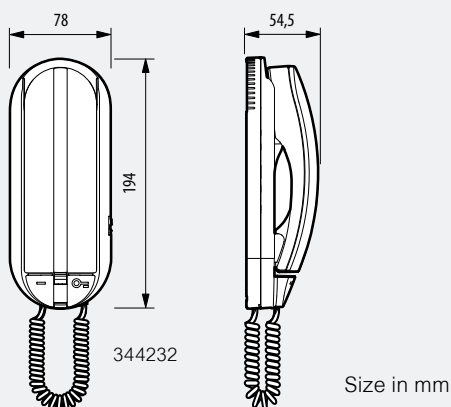

## Universal analogue audio handset



334262

Item	Universal analogue audio handset
334262	Universal audio handset that can be installed in BTicino analogue (1 + n) and (4 + n) Compatible with most competitors analogue systems. It has a lock release button and it is designed for the installation of 4 buttons accessory (Item 337430) for additional functions. Volume adjustment on 3 levels.



## Porter switchboards



346310



346300

Item	Switchboard and accessories
346310	Switchboard for 2 WIRE audio and video systems. Allows access to various services (video door entry functions, door lock/staircase light management and apartment alarm monitoring) directly from the keypad or via the intuitive icon menu. The switchboard is supplied with an integrated table supporting frame and also features a 7" colour LCD display, receiver and speaker phone, dedicated keys for the main functions and keys which can be configured. The programming can be carried out directly from the device or via PC with TiSwitchBoardDevice software (supplied). The device can manage the phonics of the riser EP (i.e. wired downstream of interface 346851); it cannot however manage the apartment EP (i.e. wired downstream of interface 346850). The use of an additional power supply is recommended. It is possible to connect up to a max. of 16 switchboards (configured from 0 to 15). <b>WARNING: the switchboard cannot be used in systems with 2 WIRE-IP interface 346890. The new HIERARCHICAL mode is available only with the entrance panels of the following series: Sfera New, Linea 100, Minisfera, Linea 300.</b>
336982	White 8-way socket for table top installation of switchboard item 346310
336803	8 – Way cable with connector for the table top installation connection.

Item	SOFTSWITCHBOARD software
346300	Switchboard software for the management of audio and video door entry system calls. The software (Windows operating system compatible) can be installed on any desktop or laptop PC, and gives the possibility of receiving, managing and transferring the calls from the entrance panel and the handset. It implements home video monitoring, with cyclical display of the cameras, night and day functions, and the possibility of displaying the alarms in the various apartments. - Supported operating systems: Microsoft Windows XP Service Pack 2, Windows Vista and Windows 7. - Software required: NET Framework 3.5 or higher

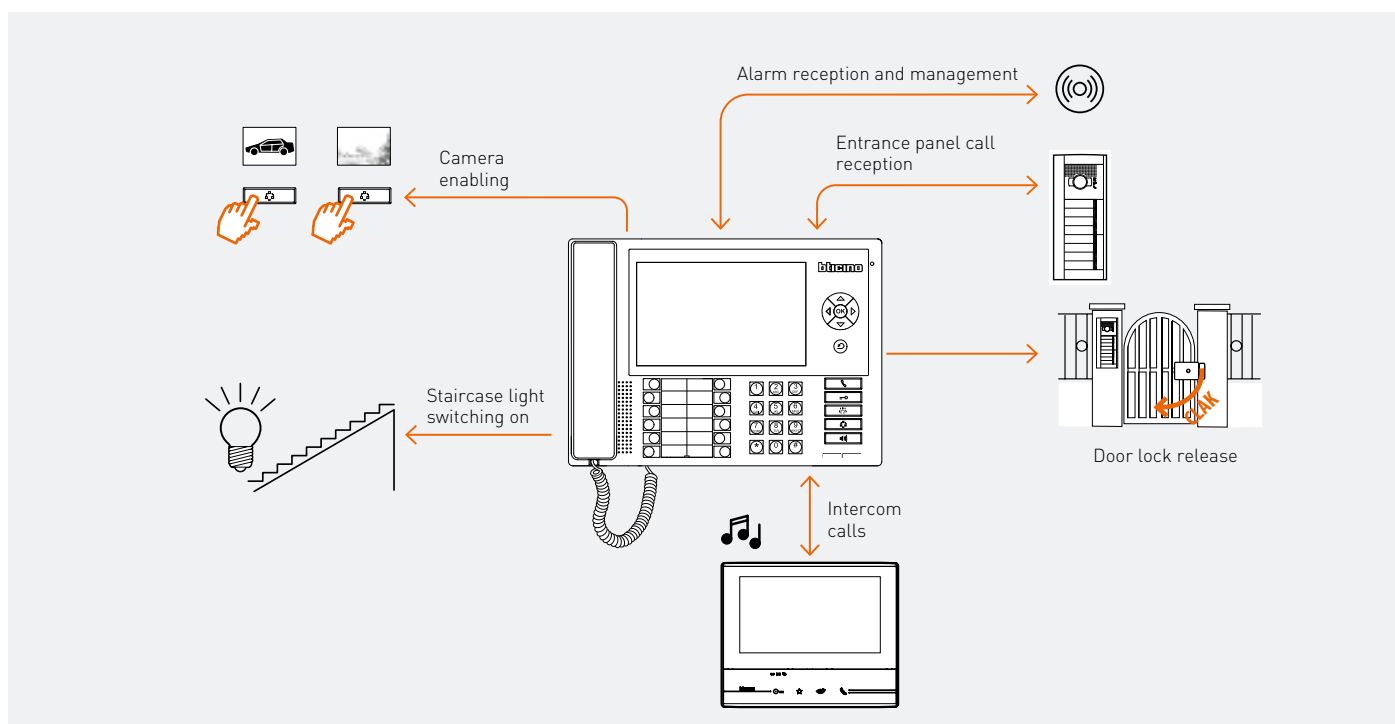



# SYSTEM ACCESSORIES RANGE

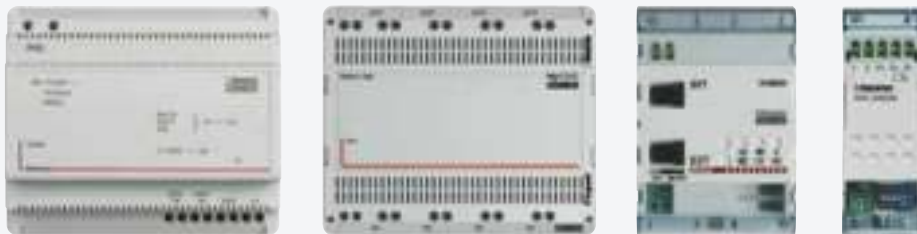





# SYSTEM ACCESSORIES

## Accessories



346050 SELV



346030 SELV



F441



346850



346851



346040 SELV



346020 SELV



F441M

Item	Power supplies
346050	Power supply for 2 WIRES system in 6 DIN modular enclosure. Power supply 110 – 240 Vac @ 50 – 60 Hz. The output provides two power supplies in very low safety voltage (one on the 3 TK BUS, IU BUS and SCS clamps, one on the 1 - 2 clamp) to be used alternately and NOT at the same time. To be used in audio, video or mixed audio video systems. The video adapter is integrated in the device (item 346830 must not be used). It is therefore possible to avoid the use of the A/V node (F441) or the Multi-channel Matrix (F441M), if three junctions (MAX 2 IU + 1 TK risers or 1 IU + MAX 2 TK risers) are not exceeded in total from the clamps. It can also be used as additional power supply (1 - 2 output) for the local power supply of the preset internal units or entrance panels (in this case it is not possible to use other outputs). The device is electronically protected against overload and short circuit. It is a SELV double insulation safety device. The installation must be made in compliance with current regulations. The device must not be configured. <b>WARNING: the (IU BUS), (TK BUS) and (SCS) outputs can be used at the same time respecting the total maximum absorption of 1.2 A. WARNING: Disconnect the power supply for 5 minutes after overload or short circuit.</b>
346040	Power supply for 2 WIRES audio systems in 6 DIN modular enclosure. Power supply 110 – 240 Vac @ 50-60 Hz. The output provides 26 Vdc low rated voltage, and a maximum rated current of 600 mA and it is protected on the PRI side (with fuse) against overload and short circuit. It is a SELV double insulation safety device.
346030	Mini power supply with integrated video adapter to make small 2-WIRES video systems (intercom). 2 DIN modular enclosure. Power supply 230 Vac @ 50-60 Hz. The output provides 27 Vdc continuous low voltage, with maximum current of 600 mA and it is protected on the PRI side (with fuse) against overload and short circuit. It is a SELV double insulation safety device.
346020	Additional power supply to be used to supply the set up entrance panels and internal units locally. 2 DIN modular enclosure. Power supply 230 Vac @ 50-60 Hz. The output provides 27 Vdc continuous low voltage, with maximum current of 600 mA and it is protected on the PRI side (with fuse) against overload and short circuit. It is a SELV double insulation safety device.

Item	Video mixers
F441	Audio video node in 6-DIN modular enclosure set up with 4 input terminals and 4 output terminals. Can connect up to 4 source devices (entrance panels or cameras) in input and up to 4 2-WIRES video risers in output. The device must be used with the system power supply 346000. It must be used as an alternative to the audio video adapter 346830
F441M	Multi-channel matrix in 10 DIN modular enclosure. Set up for the connection of video entry system entrance panels, cameras and sound system sources in input and internal units and amplifiers in output. 4 inputs are dedicated to entrance panels/cameras and 4 to the sound system sources. It can be used to create multi-channel sound systems. The device must be used with the system power supply 346000. In the systems it replaces the video adapter 346830 and the audio video node F441
346850	<b>System interfaces</b> Apartment interface in 4 DIN modular enclosure. Can interface a dedicated apartment video door system with local CCTV, sound system and control of the Home automation applications to a 2-WIRES riser. The device must be configured using physical configurators
346851	System expansion interface in 4 DIN modular enclosure. Can double the length of the entrance panel-internal unit line, create risers with independent sound and expand the performance of the apartment system. The device must be configured using physical configurators

# 2 WIRES SYSTEM SYSTEM ACCESSORIES

## Accessories



346891



346260

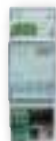

346210



346841



347400



346870



346993



346250



3499



354000

Item	Interfaces with other BTicino systems
346891	Can make very large mixed 2 WIRES/IP systems with a large number of devices, thanks to the creation of an IP backbone with 2-WIRES risers. The device must be configured using physical configurators or using the software
346150	8/2-WIRES interface in 6 DIN modular enclosure. Can make mixed video door entry systems (8-WIRES digital backbone/2-WIRES risers). The device must be configured using physical configurators
349410	Analogue/2 WIRES interface in 4 DIN modular enclosure. Can interface a dedicated apartment 2-WIRE video door entry system with cameras and control of the MyHOME applications to an analogue riser, digital 8-WIRES, audio TERSYSTEM and VIDEOPORTER 2000.
	<b>DIN actuators</b>
346210	Relay actuator in 2 DIN modular enclosure. Can switch on lights, open gates, repeat the call on bells (MOD=SLA) or control other devices from the video internal units. The device must be configured using physical configurators
346230	Door lock relay actuator in 2 DIN modular enclosure. Can supply power and activate an electrical door lock. The device must be configured using physical configurators
346260	Timed door lock relay actuator in 4 DIN modular enclosure. Can switch on lights, open gates or manage electro-magnetic door locks, timed door opening and door lock status (with NC contact). The device must be configured using physical configurators

Item	Devices in basic enclosure
346841	Floor shunt with 4 outputs Can make 2-WIRES video door entry systems with star wiring distribution. The device automatically adapts the video signal. Its small size means it can also be placed inside the flush-mounted box
346833	Call to the floor interface. By connecting a traditional pushbutton, the following functions will be possible: general call to the floor, addressed call to the floor, staircase lights on, and door lock release (specific actuator needed) and association of the video image to the call to the floor. The device must be configured using physical configurators
347400	Interface for the conversion of the coaxial signal into a 2 WIRES BUS signal. It can be used to connect to the BUS of the 2 WIRES video door entry system a camera with coaxial video output powered at 12 Vdc, with maximum absorption 150 mA and 1 Vpp video output (75 Ω). The device must be configured using physical configurators
	<b>Wiring accessories</b>
346870	2 WIRES video amplifier. In video systems wired using non-twisted wires, where the distance between the entrance panels and the internal unit exceeds 50 metres, it enables increasing such distance to up to 100 metres
346250	Relay module for gate opening to be used with LINEA 2000, LINEA 3000, MINISFERA and SFERA pushbutton panels. Can open door locks (NOT managed by BUS) by means of the entrance panel
3499	Line terminator. To be used to terminate the riser or apartment line, when the last installed device is not fitted with line closing micro switch
354000	Flat cable for the connection of several SFERA NEW and SFERA ROBUR pushbutton modules. Length 470 mm



346991

 336904  
336905

3515



3501/1



3501K

Item	Universal speaker unit and expansion module
346991	The universal speaker unit can be used to install the 2 WIRES audio system in new or refurbished systems, where pushbutton panels of other manufacturers are present or required (mail boxes, patterned brass, compact sheet metal units, etc.), preset for a traditional speaker module (e.g. 2659N). The universal speaker unit has, as base, contacts for the connection of 8 call keys; to make systems with more keys (up to 56 using the 346000 power supply and up to 24 with the 346010 power supply one or more key expansion modules must be used (1 every 8 pushbuttons).
346992	Expansion module for connecting more than 8 call keys to item 346991 - max. 6 modules (56 calls max.) with power supply 346000. Max. 2 modules (24 calls max.) with power supply 346010
	<b>Cable for systems</b>
336904	Specific cable for 2 WIRES video door entry applications with 2 twisted conductors. It can be installed in underground piping, in accordance with standards (CEI 20-13 and CEI 20-14). It ensures the best performance in video systems (higher distance between EP and Handset when compared with other cables). 200 m coil
336905	Specific cable for BUS / SCS unshielded, consisting of a white outer sheath and 2 flexible conductors twisted together with a cross section of 0.50 mm <sup>2</sup> . Halogen-free low-toxicity cable; <b>ideal for applications in environments where greater regard is required for safety in the event of fire (halogen free)</b> . 400 V insulation. Compliant with standards: EN 50575 EN60811, EN50289, EN50290, EN60228, 50265-2-1, EN50395, EN50396. Cable not suitable for burial. Coil length 200 m. Fire reaction class according to CPR regulation: Ccas1b, d1, a1.
	<b>Spare part terminal/clamp</b>
3515	Spare part terminal/clamp for BUS connection of the predisposed devices

Item	Configurators (package of 10 pieces)
3501/0	Configurator 0
3501/1	Configurator 1
3501/2	Configurator 2
3501/3	Configurator 3
3501/4	Configurator 4
3501/5	Configurator 5
3501/6	Configurator 6
3501/7	Configurator 7
3501/8	Configurator 8
3501/9	Configurator 9
3501/JMP	Configurator JMP
	<b>Configurator kit</b>
3501K	Configurator kit consisting of: - 10 pieces for each type of configurator from 0 to 9 - 2 blue removable 8-clamp connectors - 2 green removable 2-clamp connectors - 1 configurator connection tool (3502) - 1 plastic screwdriver

# 2 WIRES SYSTEM WIRING DIAGRAM EXAMPLES

## Audio system

### Example of multi-family audio system

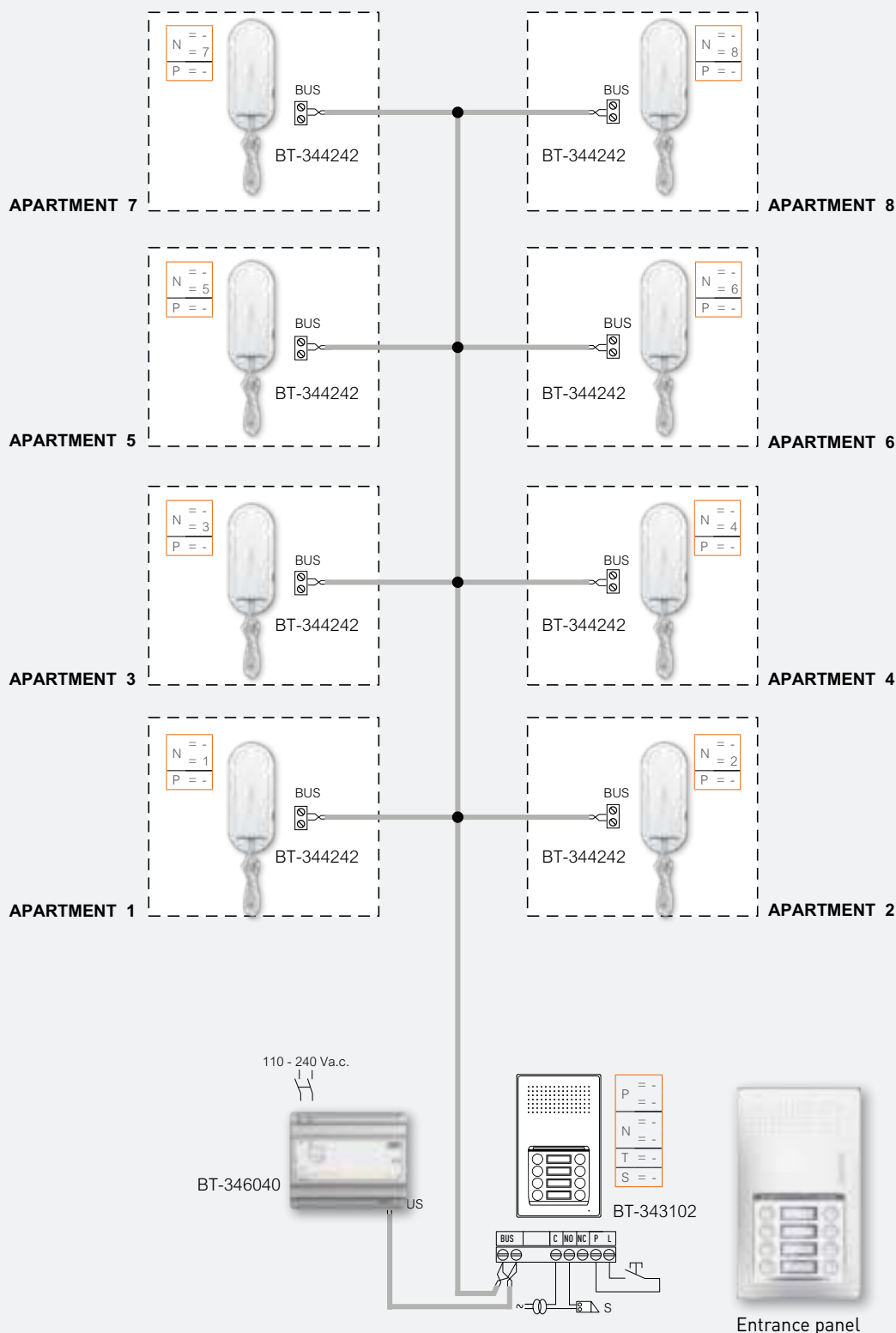

Video system

**Example of multi-family video system**

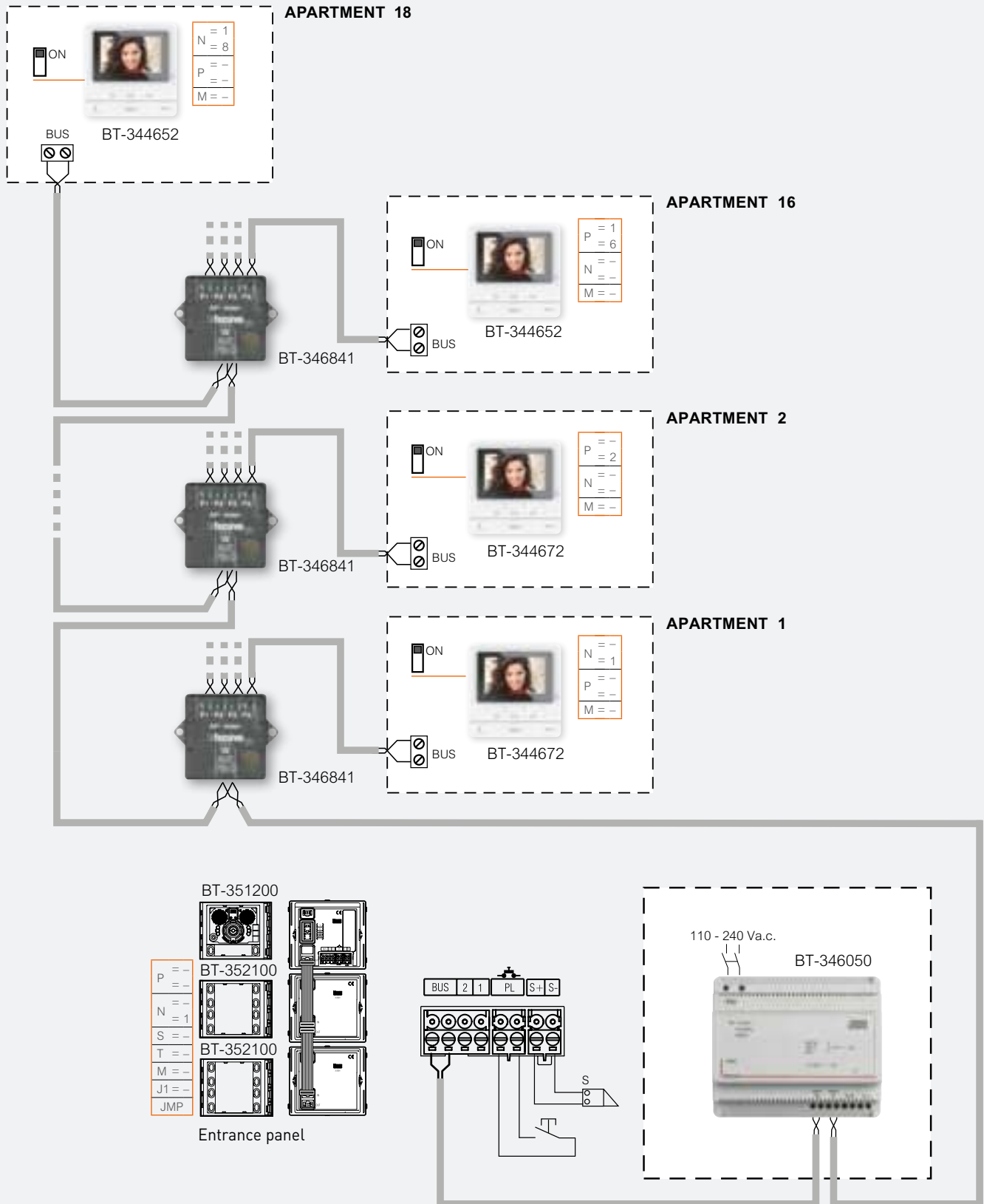



# IP SYSTEM

Video door entry system



## IP SYSTEM FOR THE BEST PERFORMANCE

The perfect solution for large residential complexes with a high number of apartments, able to guarantee high performance, long distances and high video signal quality.



## reddot winner

The "Red Dot" is a highest design quality award. The international jury only awards this sought-after seal of approval to products of outstanding design.



Entrance panel

Video indoor unit

Guard station

**Wide range of products with flexible and scalable solutions to satisfy every building needs.**

### MAIN PERFORMANCES AND FUNCTIONALITIES

**Multichannel:** for simultaneous conversations (no busy lines);

**High definition video quality:** up to 1280 x 720;

**Technology:** IP protocol (SIP/TCP);

**Cables:** FTP and UTP (CAT5 - CAT5E - CAT6) - Fiber optic

**Configuration:** easy and quick configuration with dedicated software;

**Integration:** Onvif IP Cameras, Lift control, Alarm sensors;

**App Home + Security:** incoming calls answering and door locks activation by smartphone.

# CALL THE APARTMENT ANY WAY YOU LIKE



- 1. STANDARD CALL**  
Area-Building-Riser  
Floor-Apartment
- 2. ALPHANUMERIC CALL**  
Create codes  
with numbers and letters
- 3. ADDRESSBOOK**  
With contact list  
(touch displays only)

# ACCESS THE BUILDING IN SEVERAL WAYS



**FACE RECOGNITION**



**FINGERPRINT**



**RFID CARD AND BADGE**



**ACCESS CODE**

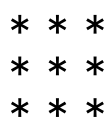

**SMARTPHONE**

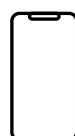





# ALWAYS AWARE WITH THE **HOME + SECURITY APP**

## THE BEST APP FOR A SAFE HOME

Alerts and notifications for incoming calls, motion and people detection, event information and door lock management with a simple and intuitive interface.

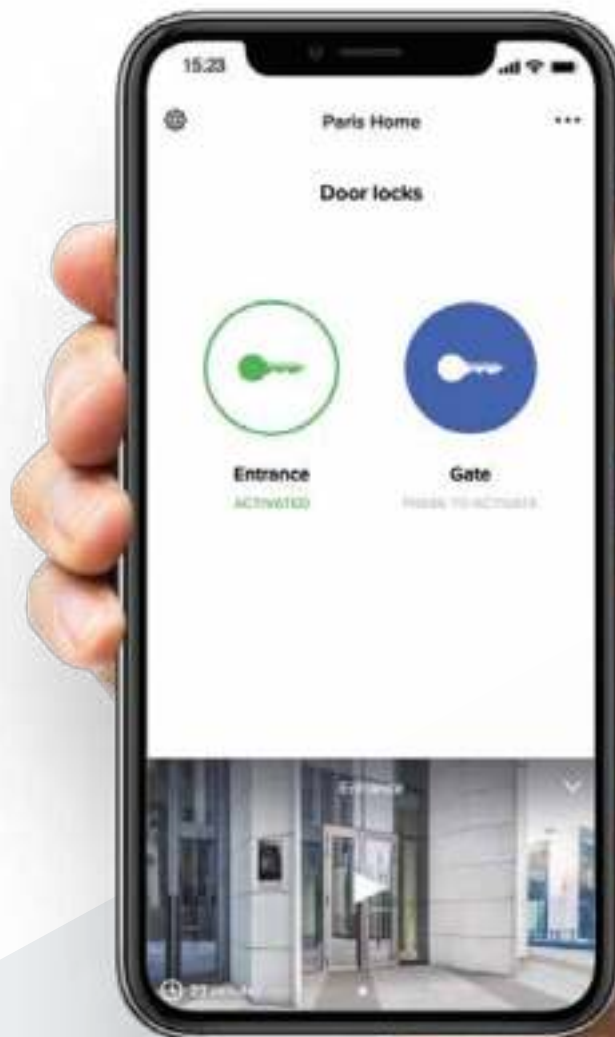

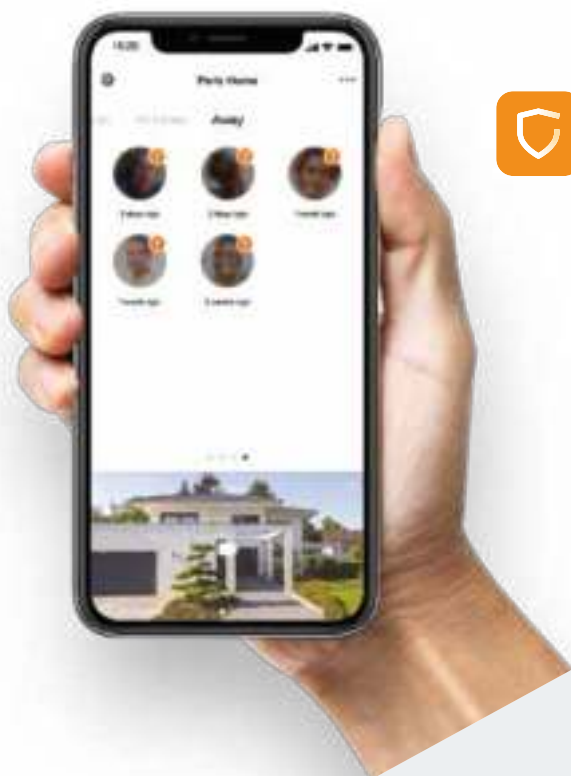

**Home + Security**  
The best App for a safe home.

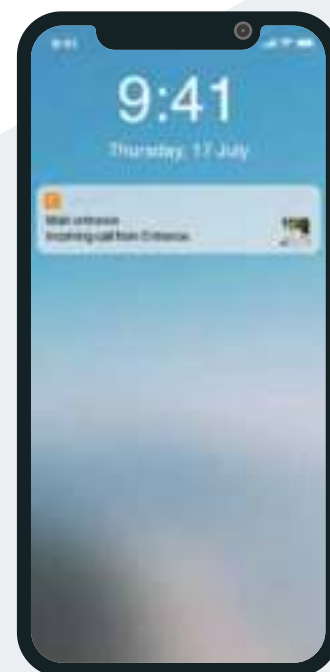

### INCOMING CALL

Receive notification when someone is calling

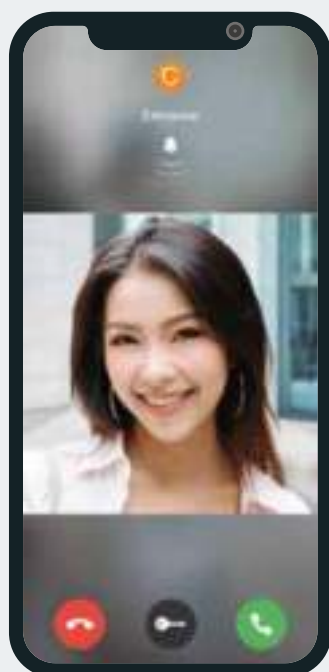

### SEE WHO'S CALLING

Answer the call and open the gate for the courier

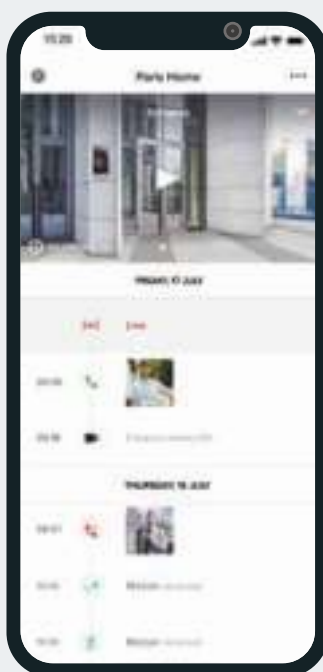

### CHECK THE EVENTS

Check who called you and if they left you a message

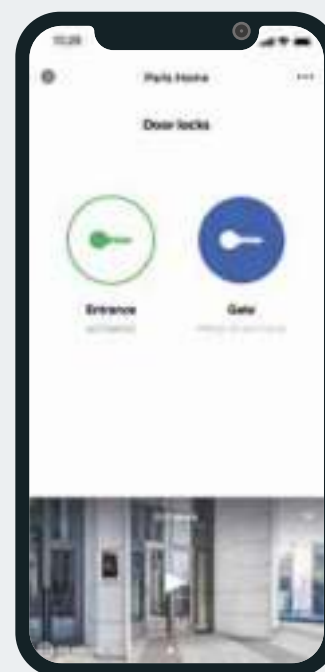

### QUICK ACTIONS

- Activate the electrical door locks
- Call home / Intercom
- Activate the cameras
- Manage the answering machine



# INTEGRATIONS

## INTEGRATION WITH ONVIF IP CAMERAS

From the Guard Station it is possible to monitor all the common area IP cameras, while from the indoor units, the resident can monitor private and common area IP cameras.



GUARD STATION



INDOOR UNIT

## INTEGRATION WITH LIFT CONTROL

Thanks to the access control function, visitors are taken directly to the floor of the called apartment while residents can call the lift from the indoor unit or when entering the building.

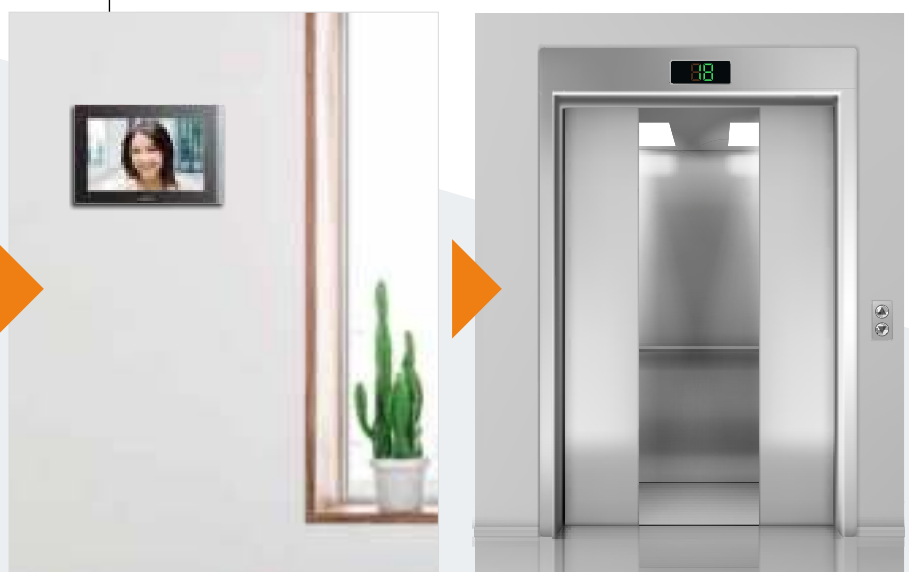
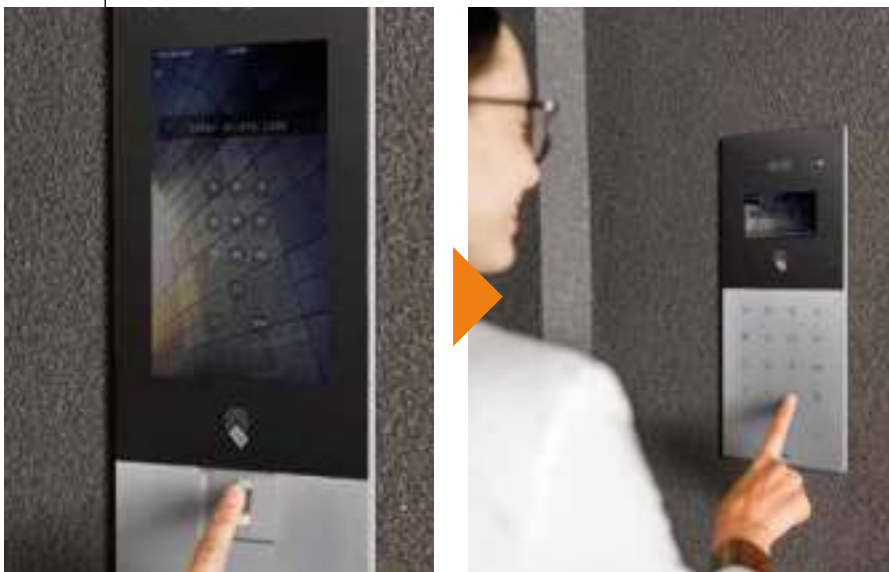

**NOTE:** integration to be performed through the Lift Control protocol translator and dedicated software.

**BTicino** SpA  
Viale Borri, 231  
21100 Varese - Italy  
[www.bticino.com](http://www.bticino.com)

BTicino SpA reserves at any time the right to modify the contents of this booklet and to communicate,  
in any form and modality, the changes brought to the same.

AD-EXCM23VDEC/ENG - Edition 10/2023

**bticino**

A Group brand |  **legrand**